

Installation Instructions for
 307021421 or 307603542 FEMCO Weather Brake
 Fits: Farmall F-544, F656, F-666, Hydro 70, 86
 Includes Hydrostatic & Hi -Clear (Gas or Diesel)

Listed and shown below are the parts required to install the 1421 or 3542 Weather Brake. Carefully study the photographs and identify all parts before starting assembly. Verify that all parts are in the box. Follow the installation steps numerically.

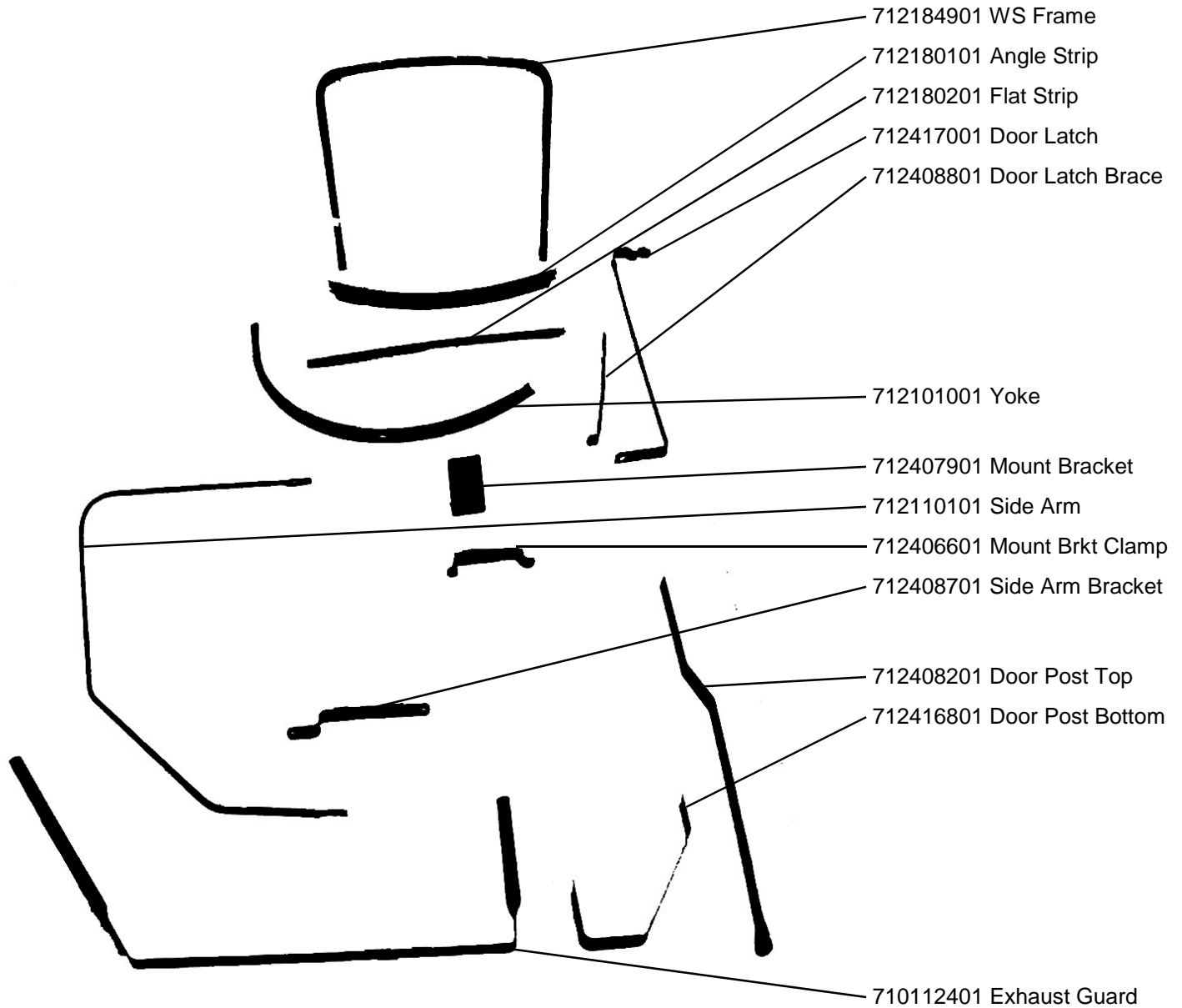

Not Shown:
 711389701 25" Windshield
 720582700 Curved Window
 720583700 Side Window
 720676305 Motor Cover
 720687305 Door Assembly
 729142100 Hardware Bag

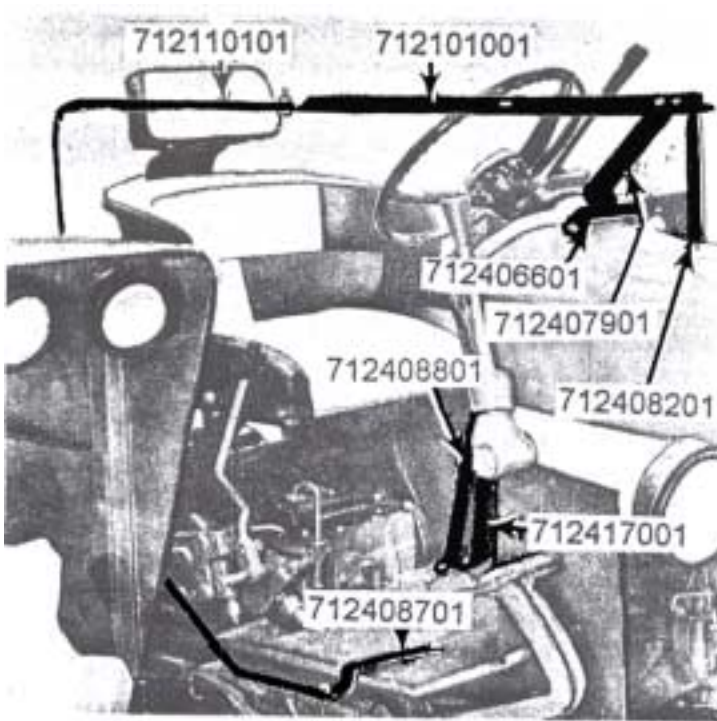

Figure 1



Figure 2



1. Attach # 712407901 Mount Bracket to # 712406601 Mount Bracket Clamp using two (2) 5/16x3/4" hex bolts and nuts. Attach Mount Bracket Clamp to tractor using two (2) 5/16x3/4" hex bolts.

2. Attach # 712408701 Side Arm Bracket to right side of platform at existing bolt hole at front of platform. Place three (3) 1/2" flat washers under the Side Arm Bracket and attach using 7/16x4 1/2" hex bolt

ON MODEL F666; DO NOT USE SIDE ARM BRACKET. After Step 4 drill a 13/32" diameter hole in platform opposite indentation where side arm touches and bolt side arm to deck using 3/8x1 1/2" hex bolt and nut.

3 Attach # 710112401 Exhaust Guard to tractor hood over exhaust manifold so Motor Cover can not contact exhaust system. Reference Figure 3

4. Insert # 712110101 Side Arm into Wide hem on right side of Motor Cover. Insert # 712101001 Yoke into wide hem at top of Motor Cover. Attach Yoke to Side Arm using 3/8x1 1/2" hex bolt and wing nut. Place bolt head under assembly and nut on top.

Step 1

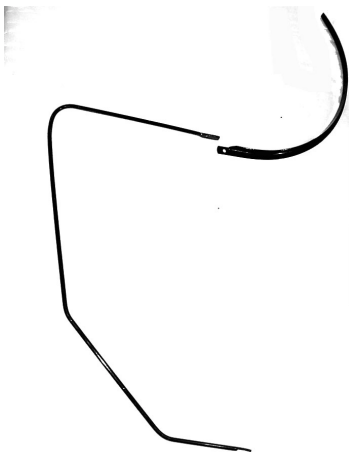

Step 2

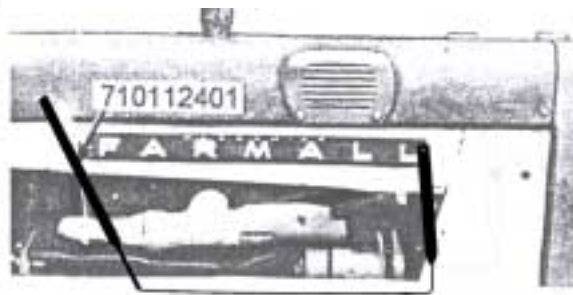

Figure 3

5. Place Motor Cover over tractor. Attach Yoke to Mount Bracket using two (2) 1/4x3/4" hex head bolts and nuts. Place bolt heads to front and nuts to rear. Attach bottom of Side Arm to Side Arm Bracket or platform (see step 2) using 3/8x1 1/2" hex bolt and nut.



6. Attach # 712408201 Door Post Top to # 712416801 Door Post Bottom using two (2) 5/16x3/4" hex bolts and nuts. Slide the Door Post assembly up in the wide hem on the left side of the Motor Cover. Attach the top of the Door Post to the Yoke using 1/4x1" hex nut and bolt. Place the bolt head at the rear of the assembly and the nut to the front. Attach the bottom of the Door Post to tractor using 3/8x1 hex bolt.

Step 5A

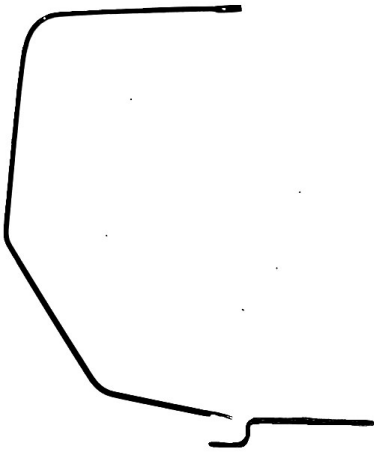

7. Straighten the Motor Cover on the tractor. Tie straps to grommets on side of the Motor cover. Attach springs to grommets on the other side of the Motor Cover. Attach straps to springs using buckles. Adjust straps so tension is maintained on springs.

8.. Find hinge holes in Door Post and punch holes through Motor Cover at hole locations. Place Door Assembly level with the bottom of the Yoke and mark Door post hole locations. Cut slits in Door Assembly around wire frame and insert F1 clips. Attach F1 clips to Door Post using 3/16x3/4" hex bolts and nuts. Tie straps sewn on Motor cover to Door Assembly grommets. See Window Assembly Instructions

Step 5B



9. Attach # 712408801 Door Latch Brace to # 712417001 Door Latch at top hole using 5/16x3/4" hex bolt and nut. Place three (3) 1/2" flat washers under the Door Latch and attach the Door Latch and Door Latch Brace to existing hole in platform using 7/16x4 1/2" hex bolt. Drill 13/32" diameter hole through second hole in Door Latch and attach to deck using 3/8x1 1/2" hex bolt.

Step 6A



Step 6B

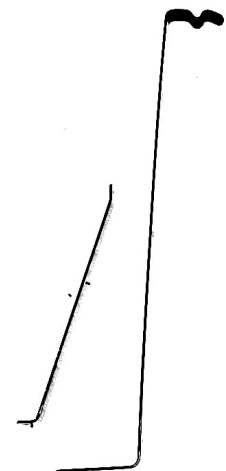

Step 9

WINDSHIELD/SIDE WINDOW ASSEMBLY INSTRUCTIONS

The pictures shown are generic drawings. The part shapes shown may vary from the parts supplied with this WB. The descriptions should be correct. Follow the instructions by step.

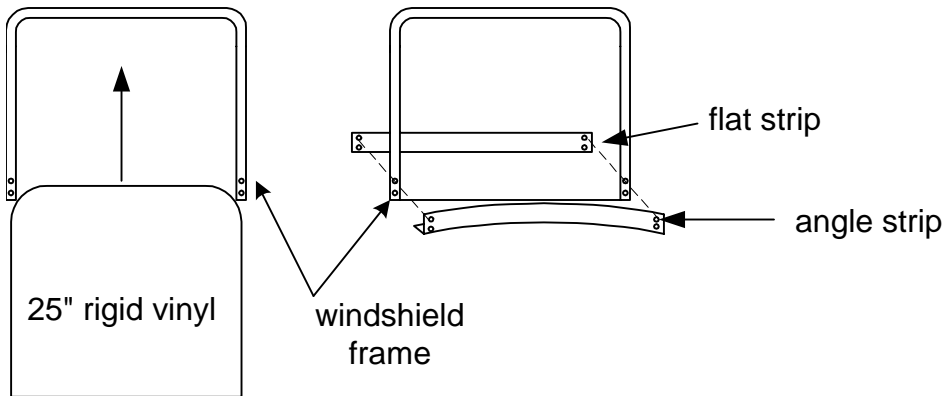

1. Slide the rigid vinyl into the windshield frame
2. Fasten the flat strip and angle strip to the windshield frame using 2 - 3/16 x 3/4 bolts in the top holes. Tighten nuts.

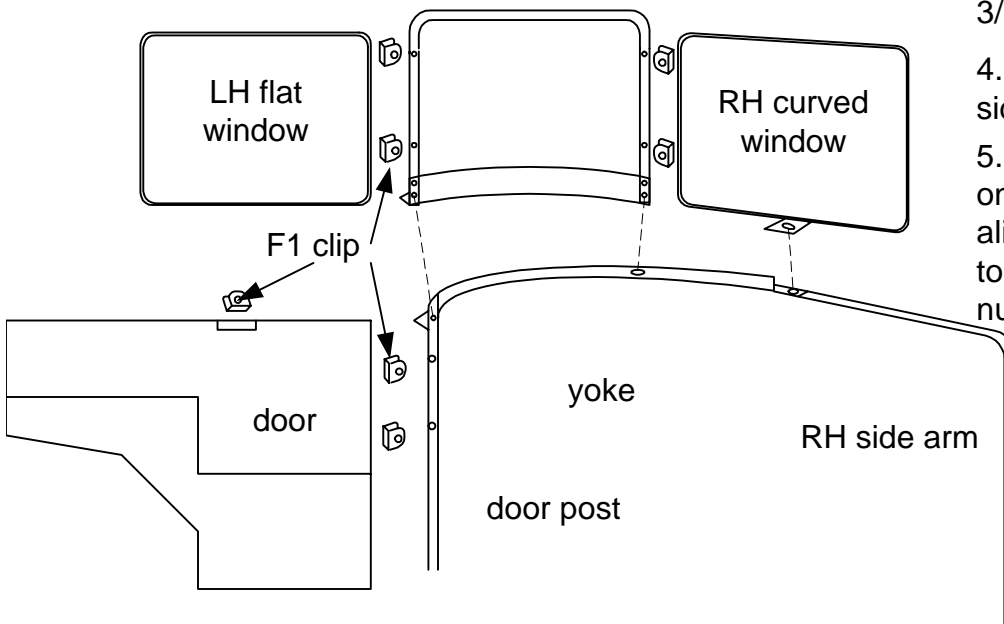

3. Cut slots in RH curved window to match holes in frame. Insert F1 clips in slots, around wire, and bolt to frame using 2- 3/16 x 3/4" bolts and nuts
4. Repeat step 3 for LH side window.
5. Place windshield assembly on yoke so lower RH hole aligns with slot in yoke. Bolt to yoke using 1/4 x 1 bolt and nut.

6. Remove nut, place lower LH hole over existing bolt at door post/yoke and replace nut.

7. Remove the nut and place the bottom of the RH side window over the existing bolt at the yoke/ side arm. Replace the nut.

8. Place an F1 clip through the cut out in the top of the door. Punch a small hole through the vinyl in the LH side window and bolt using a 3/16 x 3/4 bolt and nut

FEMCO, Inc.

General Offices
1132 W. 1ST STREET
Mcpherson, KS 67460
Phone: 620-241-3513
Toll Free 1-800-677-0898
Fax: 620-241-3532
www.femcomfg.com