

Installation Instructions for  
 307021429 or 307603558 FEMCO Weather Brake  
 Fits: Farmall F-826, F1026, F-756, F-856, F-1256, F-1456  
 (Gas or Diesel) ( Hydrostatic)

Listed and shown below are the parts required to install the 1429 or 3558 Weather Brake. Carefully study the photographs and identify all parts before starting assembly. Verify that all parts are in the box. Follow the installation steps numerically.

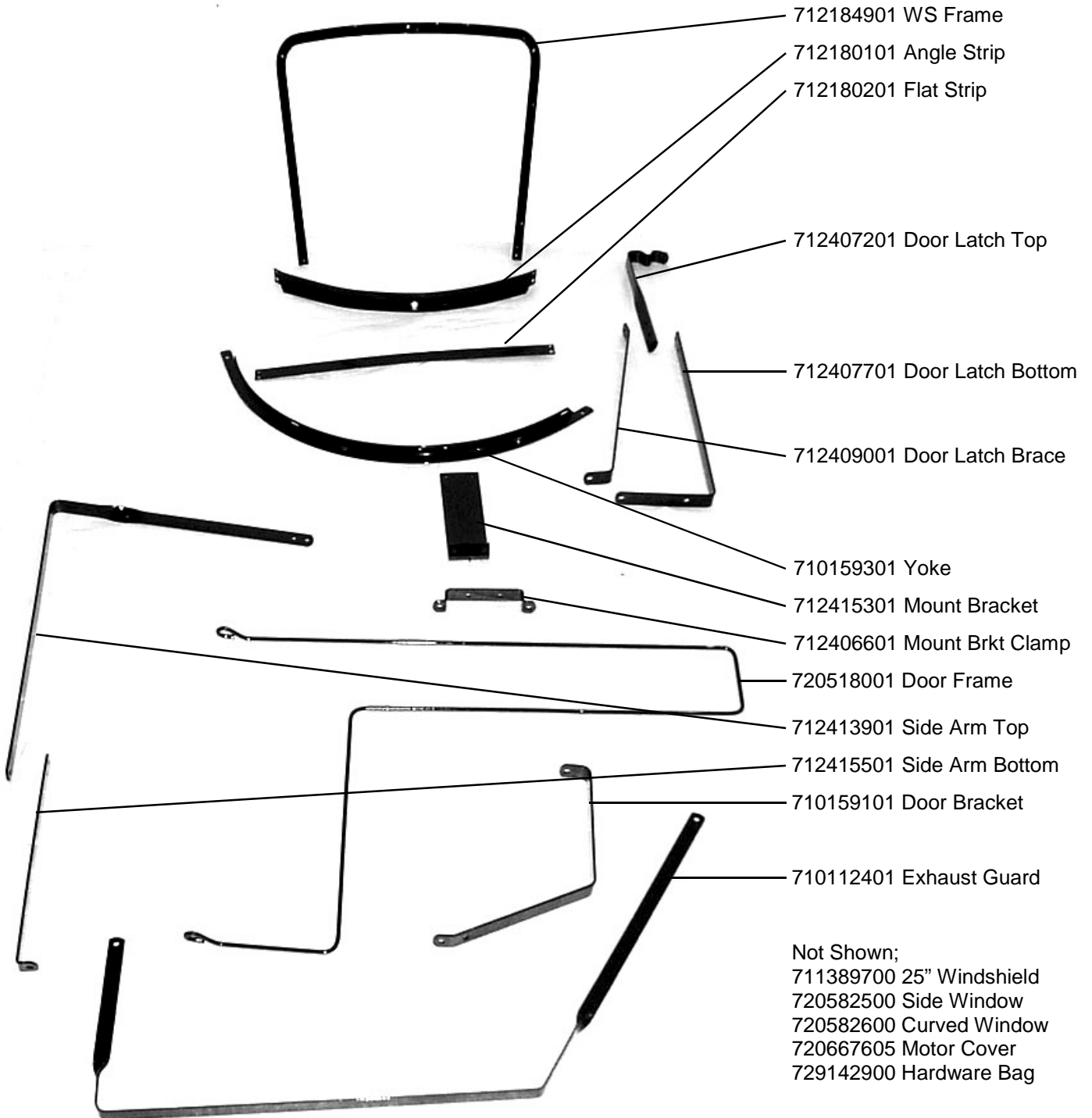

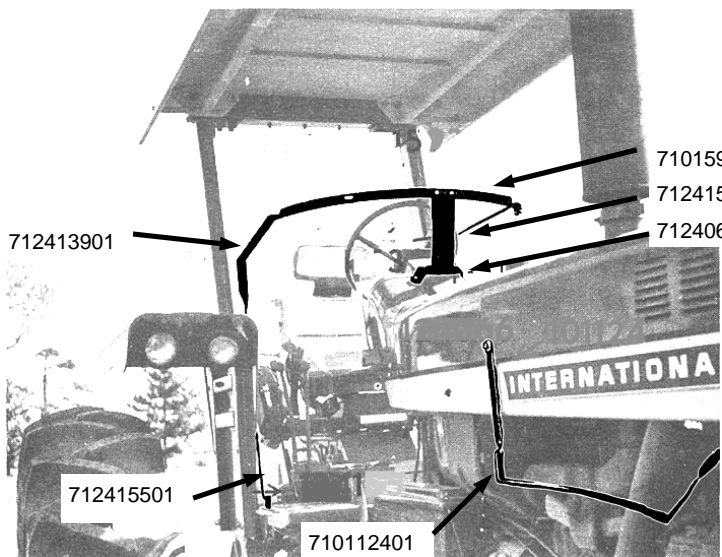

Figure 1

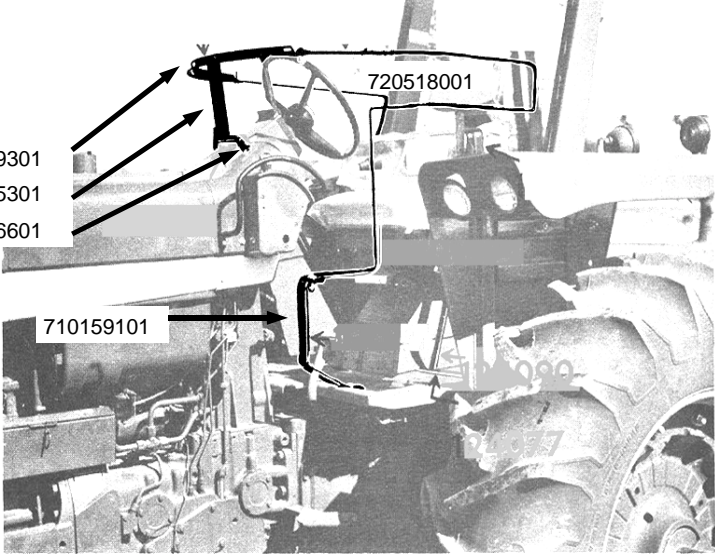
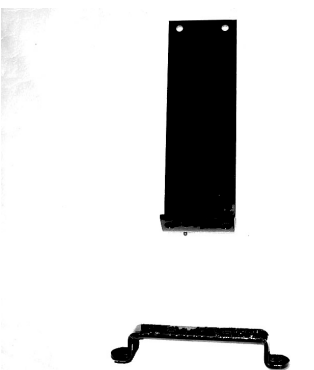
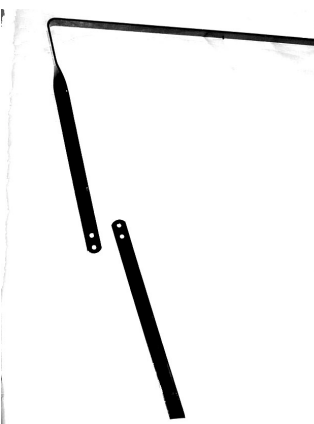

Figure 2



Step 1

1. Attach # 712415301 Mount Bracket to # 712406601 Mount Bracket Clamp using two (2) 5/16x3/4" hex bolts and nuts.
2. Attach Mount Bracket clamp to tractor cowl using 5/16x3/4" hex bolts. See Figure 1 & 2
3. Attach # 710112401 Exhaust Guard to tractor cowl so Motor Cover does not contact exhaust system See Figure 1



Step 4

4. Attach # 712415501 Side Arm Bottom to # 712413901 Side Arm Top using two (2) 5/16x3/4" hex bolts and nuts.
5. Insert Side Arm Assembly into wide hem on right side of Motor Cover. Insert # 710159301 Yoke into top hem on Motor Cover. Attach Yoke to Side Arm Assembly using one (1) 3/8x1 1/2" hex bolt and nut. Place bolt head under assembly and nut on top.

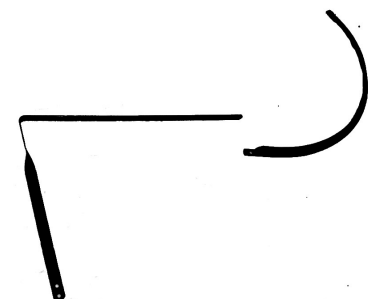

Step 5

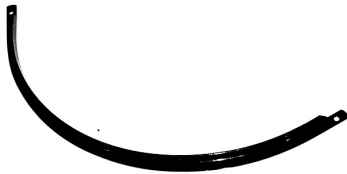

6. Place Motor Cover over tractor. Attach Yoke to Mount Bracket using two 1/4x3/4" hex bolts and nuts. Place bolt heads to front and nuts to rear. Attach Side Arm Assembly to existing hole in platform. Place spacer under Side Arm Bottom and use 3/8x2 1/2" hex bolt and nut.

**Model F-756 DO NOT USE SPACER attach Side Arm Bottom to platform using 3/8x1 1/2" hex bolt**



6. Place # 710159101 Door Bracket to platform on left side directly under end of Yoke. Using Door Bracket as template drill 13/32" diameter hole through end hole and use 3/8x1 1/2" hex bolt and nut to attach bracket.

Step 6

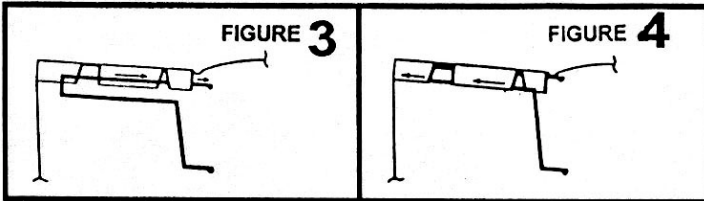

7. Slide # 720518001 door frame into first wide loop in left side of Motor Cover and push toward front. When frame is as far forward as it can go push toward rear into second wide loop in Motor cover and push back until frame stops. See Figure 3 & 4



8. Attach top of Door Frame to Yoke using 3/8x1 1/2" hex bolt, flat washer and two (2) nuts.

9. Attach bottom of Door Frame to Door Bracket using 3/8x1 1/2" hex bolt, flat washer and two (2) nuts locked together.

**Model F-756 use 3/8x2 1/2" hex bolt and spacer below Door Bracket. Place flat washer on each side of door frame. See Figure 4**

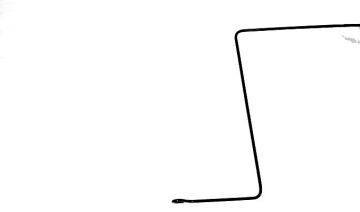

10. Straighten the Motor Cover on the tractor. Tie straps to grommets on side of the Motor Cover. Attach springs to grommets on the other side of the Motor Cover. Attach straps to springs using buckles. Adjust straps so tension is maintained on springs. Tie straps on inside of Motor Cover on left side to Door Bracket to keep fabric from going too far forward.

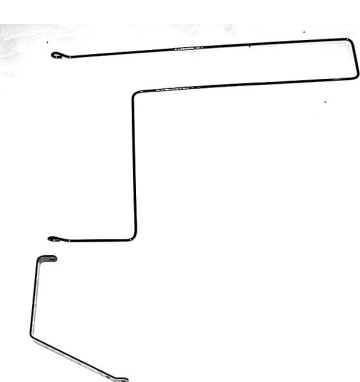

11. Attach # 712407801 Door Latch Top, # 712407701 Door Latch Bottom and # 712409001 Door Latch Brace at top set of holes using 5/16x3/4" hex bolts and nuts.

**On Model F-756 use short set of holes.**

Remove bolt in platform next to seat and attach Door Latch and Door Latch Brace using 3/8x1 1/2" hex bolt and nut. Drill 13/32" diameter hole through platform at second hole in Door Latch and attach using 3/8x1 1/2" hex bolt and nut.

12. When installing windows use larger F2 clip to attach left side window to door frame.

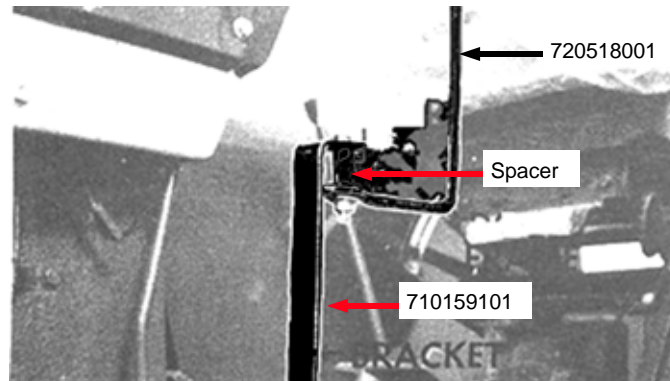
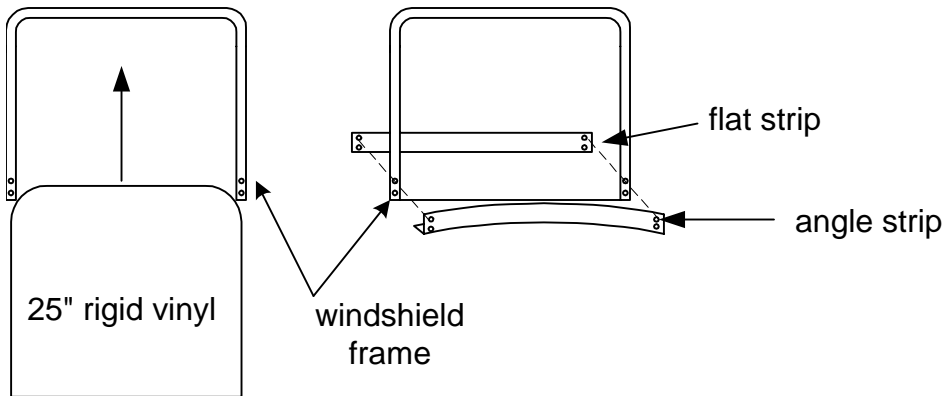

Figure 4

## WINDSHIELD/SIDE WINDOW ASSEMBLY INSTRUCTIONS

The pictures shown are generic drawings. The part shapes shown may vary from the parts supplied with this WB. The descriptions should be correct. Follow the instructions by step.



1. Slide the rigid vinyl into the windshield frame
2. Fasten the flat strip and angle strip to the windshield frame using 2 - 3/16 x 3/4 bolts in the top holes. Tighten nuts.

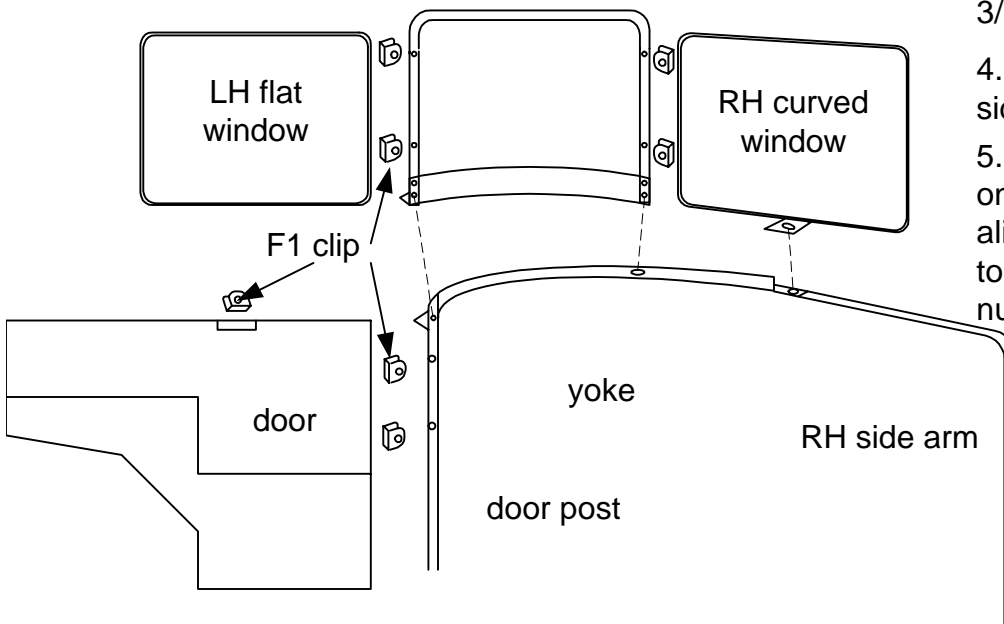

3. Cut slots in RH curved window to match holes in frame. Insert F1 clips in slots, around wire, and bolt to frame using 2- 3/16 x 3/4" bolts and nuts
4. Repeat step 3 for LH side window.
5. Place windshield assembly on yoke so lower RH hole aligns with slot in yoke. Bolt to yoke using 1/4 x 1 bolt and nut.

6. Remove nut, place lower LH hole over existing bolt at door post/yoke and replace nut.

7. Remove the nut and place the bottom of the RH side window over the existing bolt at the yoke/ side arm. Replace the nut.

8. Place an F1 clip through the cut out in the top of the door. Punch a small hole through the vinyl in the LH side window and bolt using a 3/16 x 3/4 bolt and nut



General Offices  
1132 W. 1ST STREET  
Mcpherson, KS 67460  
Phone: 620-241-3513  
Toll Free 1-800-677-0898  
Fax: 620-241-3532  
[www.femcomfg.com](http://www.femcomfg.com)