

Installation Instructions for
 307021094 or 307603591 FEMCO Weather Brake
 Fits: John Deere 530, 630, 730 Row Crop
 (LPG, Gas & Diesel with Electric Starter)

Listed and shown below are the parts required to install the 1094 or 3591 Weather Brake. Carefully study the photographs and identify all parts before starting assembly. Verify that all parts are in the box. Follow the installation steps numerically.

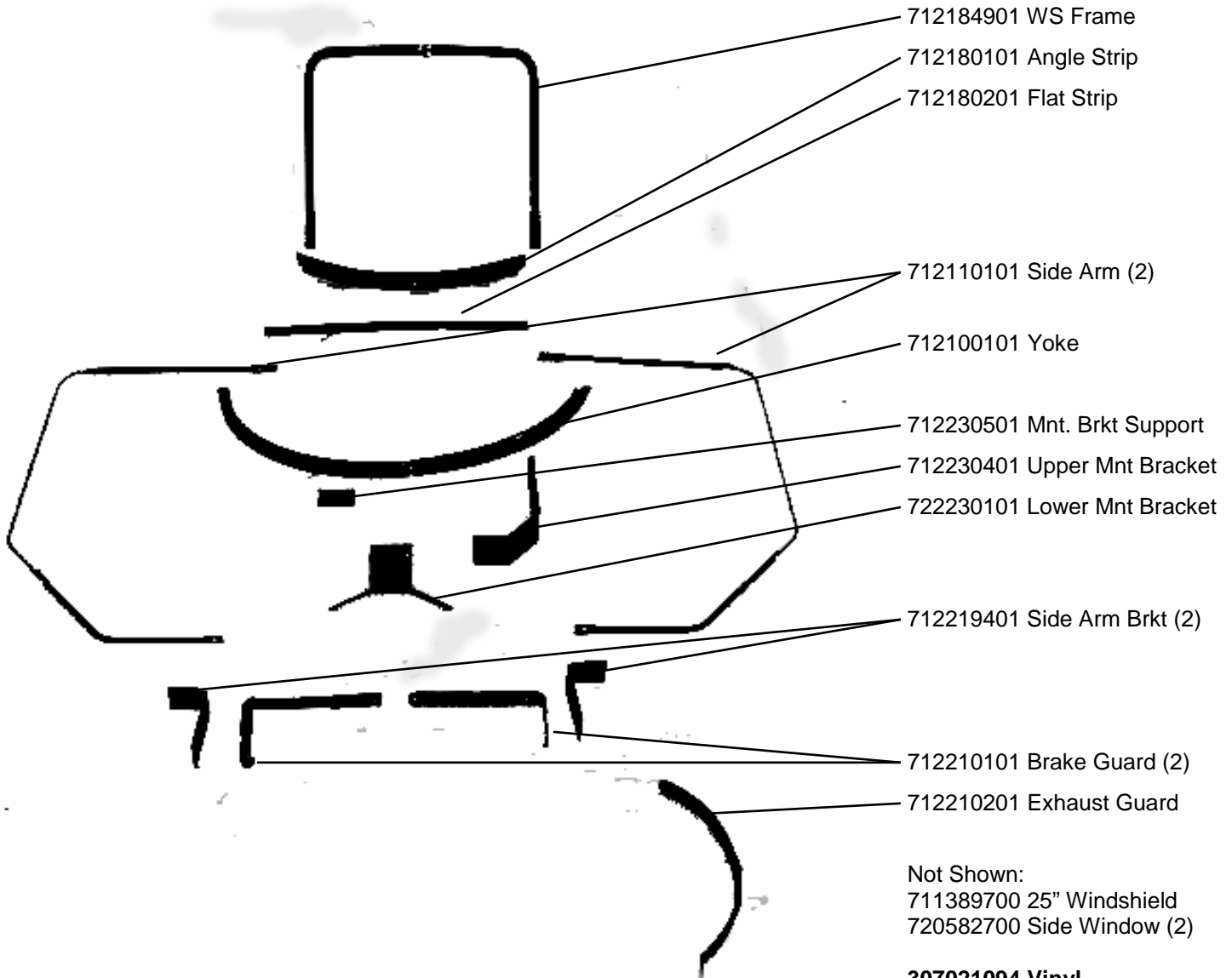

Not Shown:
 711389700 25" Windshield
 720582700 Side Window (2)

307021094 Vinyl
 720668904 Motor Cover
 729109400 Hardware Bag

307603591 Canvas
 720860504 Motor Cover
 729359100 Hardware Bag

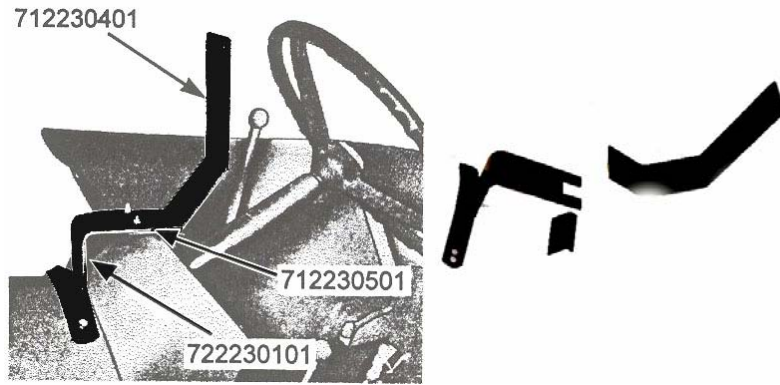

Figure 1

Lower Mount, Mount Support & Upper Mount for 530

1. Install the mount bracket as follows;

Model 530– Attach # 722230101 Lower Mount Bracket to hood using 5/16x1" hex bolts. Attach # 712230401 Upper Mount Bracket and # 712230501 Mount Bracket Support to the Lower Mount Bracket using 5/16x1" hex bolts and nuts. See Figure 1

Model 630– Attach # 722230101 Lower Mount Bracket to hood using 5/16x1" hex bolts. Attach # 712230401 Upper Mount Bracket to the Lower Mount Bracket at the rear set of holes using 5/16x1" hex bolts and nuts. See Figure 2

Model 730– Attach # 722230101 Lower Mount Bracket to hood using 5/16x1" hex bolts. Attach # 712230401 Upper Mount Bracket to the Lower Mount Bracket at the rear set of holes using 5/16x1" hex bolts and nuts. See Figure 2

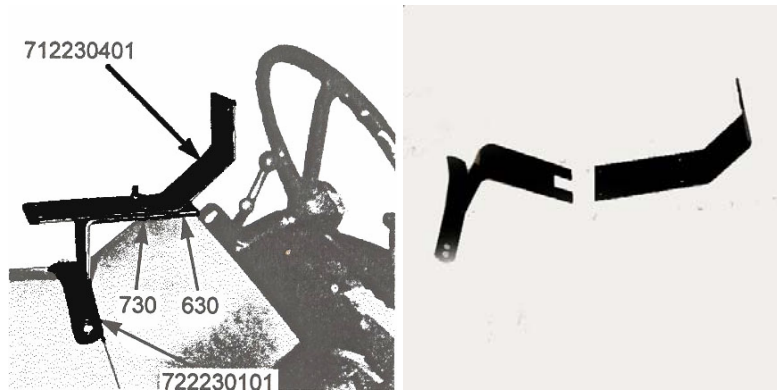

Figure 2

Lower & Upper Mount for 630, 730

2. Attach # 712210201 Exhaust Guard to tractor frame See Figure 3

3. Attach # 712210101 Brake Drum Guards and # 712219401 Side Arm Brackets to the front side of the axle housing on existing bolt. See Figure 4

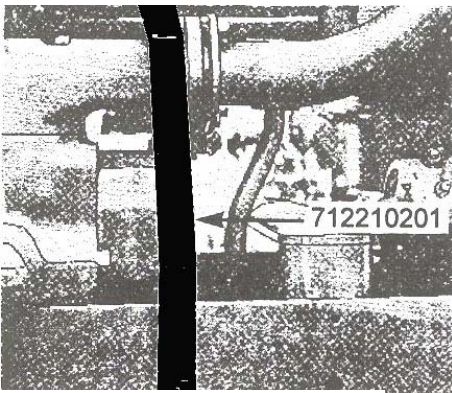

Figure 3

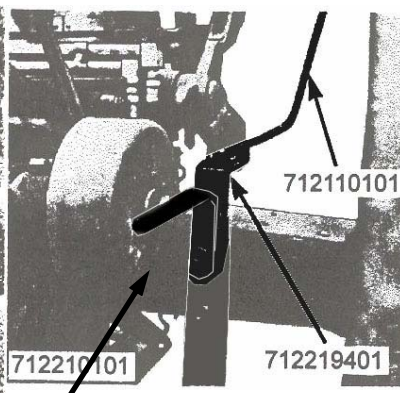
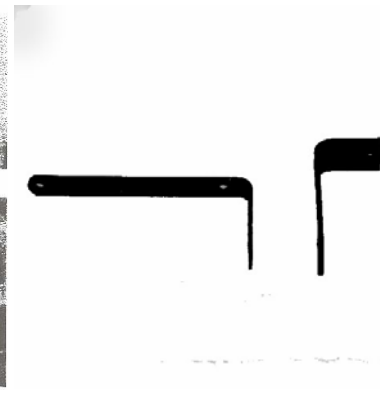
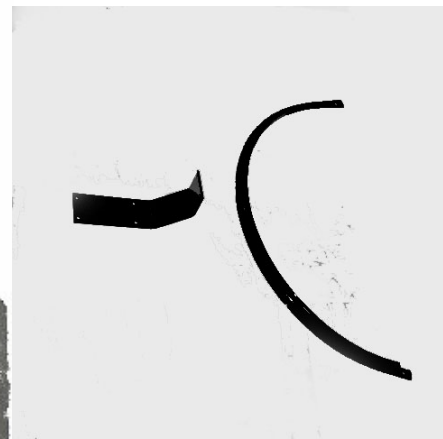
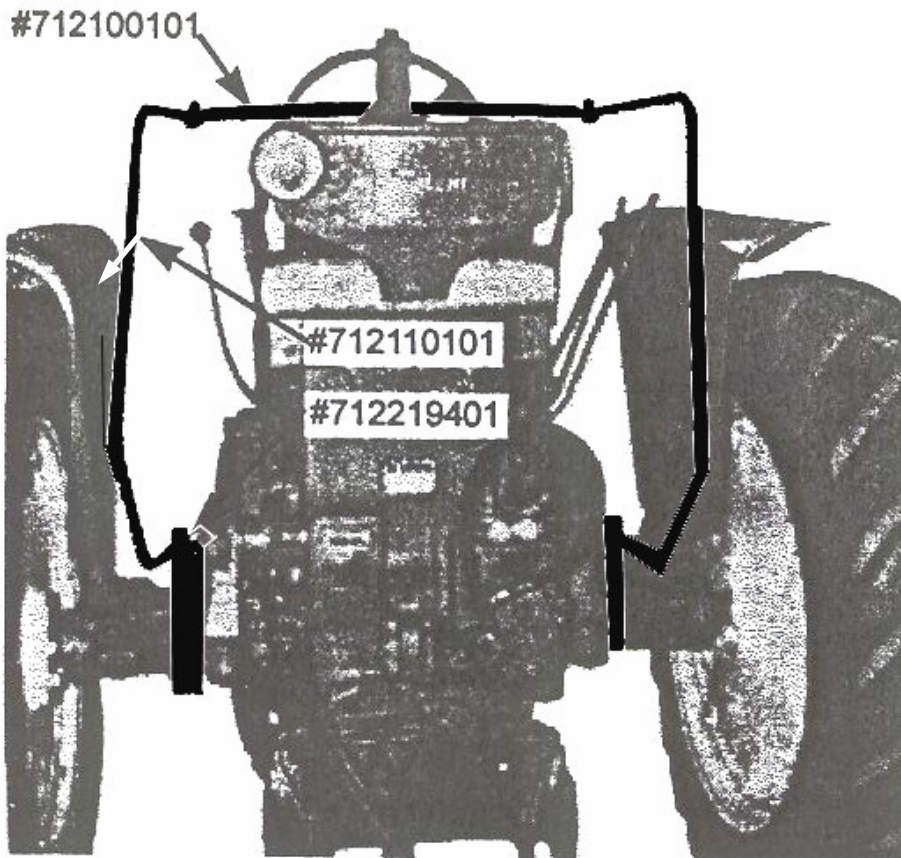

Figure 4



Brake Drum Guard & Side Arm Mount

4. Insert # 712100101 Yoke into the wide hem at the top of the Motor Cover. Insert # 712110101 Side Arms into the wide hems on each side of the Motor Cover. Place the Motor Cover over the tractor hood.



Upper Mount Bracket & Yoke

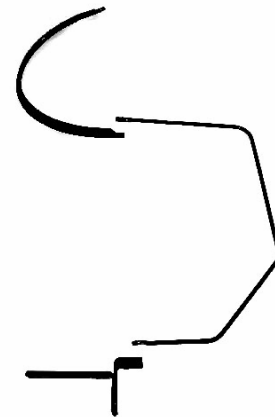

Yoke, Side Arm & Side Arm Bracket

Figure 5

5. Attach the Yoke to the previously installed Upper Mount Bracket using 1/4x3/4" hex bolts and nuts. Place the bolt heads to the front and the nuts to the rear of the assembly. Attach the Side Arms to each end of the Yoke using 3/8x1 1/2" hex bolt and wing nuts. Place the bolt head under and the nut on top of the assembly. Attach the bottom of the Side Arms to the Side Arm Bracket using 3/8x1 1/2" hex bolts and nuts. See Figure 5

6. Straighten the Motor Cover on the tractor. Tie straps to grommets on side of the Motor cover. Attach springs to grommets on the other side of the Motor Cover. Attach straps to springs using buckles. Adjust straps so tension is maintained on springs.

7. **Model 530**—To ensure a snug fit it is necessary to insert a tie strap in the two grommets located at a point just ahead of the windshield and on top of the hood. Fold the cover "IN" between the grommets and lace the grommets together. This step is not required for Model 630 or 730. See **NOTE** below

NOTE: Use first grommet for bottom strap at pulley and fly wheel openings on 530 and 630.

Fold corner of cover under and use second grommet on 730 models.

WINDSHIELD/SIDE WINDOW ASSEMBLY INSTRUCTIONS

The pictures shown are generic drawings. The part shapes shown may vary from the parts supplied with this WB. The descriptions should be correct. Follow the instructions by step.

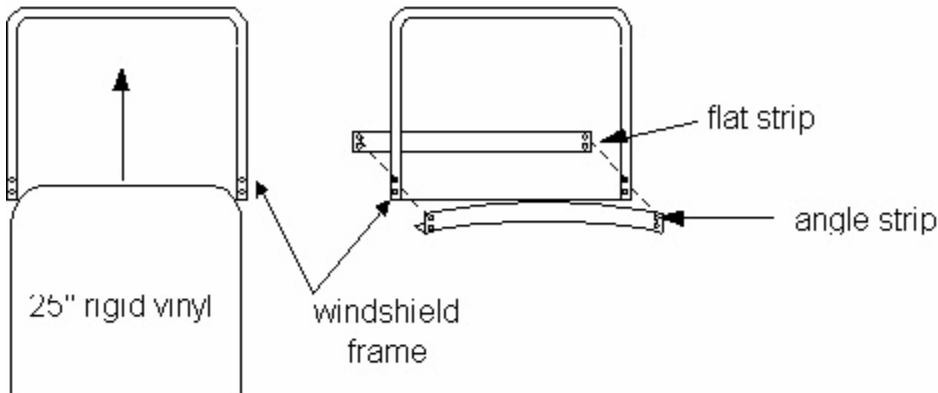

1. Slide the rigid vinyl into the windshield frame

2. Fasten the flat strip and angle strip to the windshield frame using 2 - 3/16 x 3/4 bolts in the top holes. Tighten nuts.

3. Cut slots in RH curved window to match holes in frame. Insert F1 clips in slots, around wire, and bolt to frame using 2- 3/16 x 3/4" bolts and nuts

4. Repeat step 3 for LH side window.

5. Place windshield assembly on yoke so lower RH hole aligns with slot in yoke. Bolt to yoke using 1/4 x 1 bolt and nut.

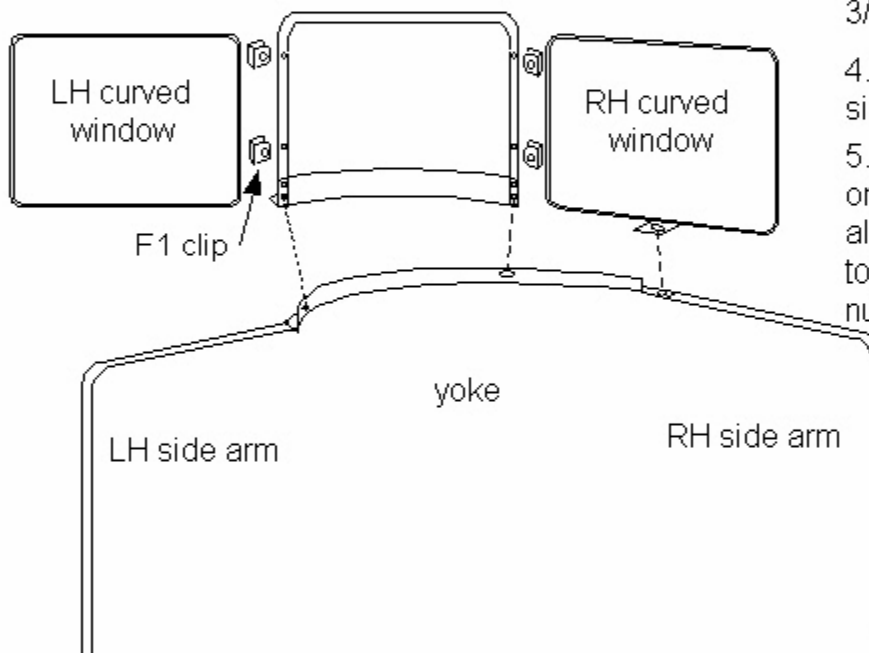

6. Align lower LH hole to hole in yoke. Bolt to yoke using 1/4x1 bolt and nut.

7. Remove the nut and place the bottom of the RH side window over the existing bolt at the yoke/ side arm. Replace the nut. Repeat procedure for LH side window.

FEMCO, Inc.

General Offices
500 North 81 By-Pass
Mcpherson, KS 67460
Phone: 620-241-3513
Toll Free 1-800-677-0898
Fax: 620-241-3532
www.femcomfg.com