

Introduction

2143

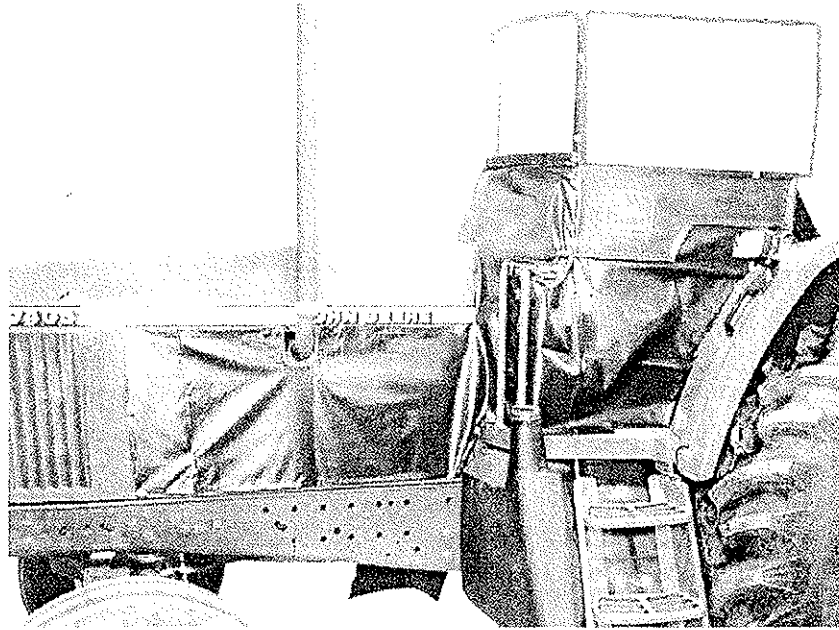

THANK YOU for purchasing a John Deere product.

READ THIS MANUAL carefully to learn how to operate and service your machine correctly. Failure to do so could result in personal injury or equipment damage.

THIS MANUAL SHOULD BE CONSIDERED a permanent part of your machine and should remain with the machine when you sell it.

MEASUREMENTS in this manual are U.S. customary units and their metric equivalents.

RIGHT-HAND AND LEFT-HAND sides are determined by facing in the direction of forward travel.

Accurately record all identification numbers to help in tracing the machine should it be stolen. Your dealer also needs these numbers when you order parts. If

this manual is kept on the machine, also file the identification numbers in a secure place off the machine.

WARRANTY is provided as part of John Deere's support program for customers who operate and maintain their equipment as described in this manual. The warranty is explained on the warranty certificate which you should have received from your dealer.

This warranty provides you the assurance that John Deere will back its products where defects appear within the warranty period. In some circumstances, John Deere also provides field improvements, often without charge to the customer, even if the product is out of warranty. Should the equipment be abused, or modified to change its performance beyond the original factory specifications, the warranty will become void and field improvements may be denied.

GENERAL INFORMATION

IMPORTANT: Read and understand all instructions before mounting weathershield.

1. Left-hand and right-hand side are determined from normal driving position of tractor facing forward.
2. All bolts, cap screws, etc. are to be installed from outside to inside weathershield unless otherwise instructed.
3. Do not tighten hardware until instructed to do so.

OMTYMB1,B -19-05AUG98

TOOLS REQUIRED

18 mm socket or combination wrench
10 mm socket or combination wrench
3/8 in. socket or combination wrench
7/16 in. socket or combination wrench
9/16 in. socket or combination wrench
Utility knife or scissors
Drill with 9/32 in. drill bit

OMTYMB1,C -19-05AUG98

Pre-Installation

TRACTOR CONFIGURATION

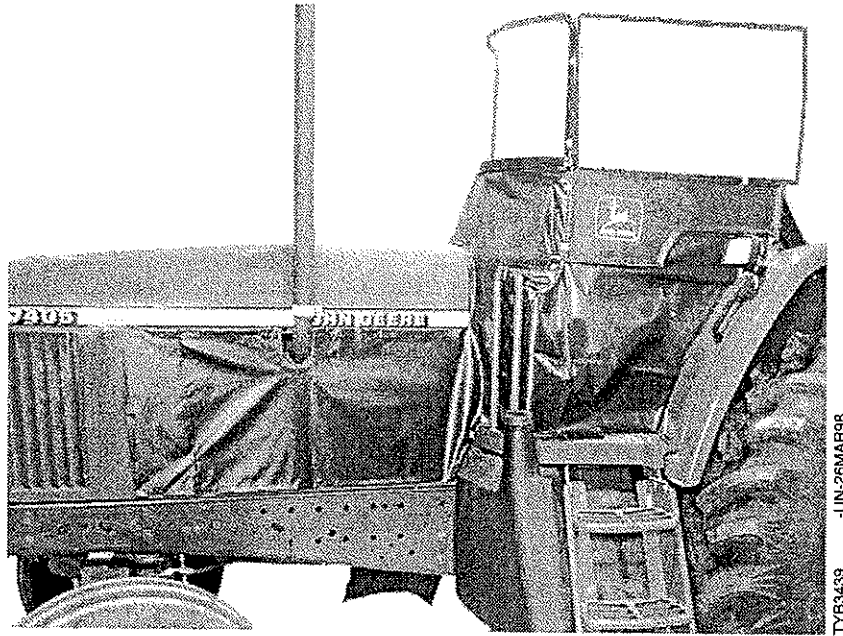

TYB3439 -JUN-26MAR98

This manual provides installation instructions for Weathershields on 6405, 6605 and 7405 Tractors.

OMTYMB1,A -19-05AUG98

PREPARE ENCLOSURE

1. Unpack carton.
2. Identify parts with exploded views and line art found on the following pages.

NOTE: Specifications may change without notice. Components may not appear to be identical to those illustrated, but will be functionally interchangeable.

3. Set out parts and hardware.

NOTE: Position enclosure parts near point of use (e.g., left door near left side of tractor), and layout tools close to work area to save time and simplify installation.

4. Count the hardware.

NOTE: Extra hardware may be provided due to pre-packaging.

TY24012,D -19-02AUG96

PREPARE TRACTOR

1. Park tractor on a firm and level surface.
2. Disengage PTO drive, lower any or all attachments.
3. Apply parking brake.
4. Stop engine. Allow it to cool.
5. Remove ignition key.

TY24012,E -19-02AUG96

HARDWARE COMPONENTS

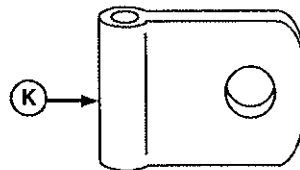
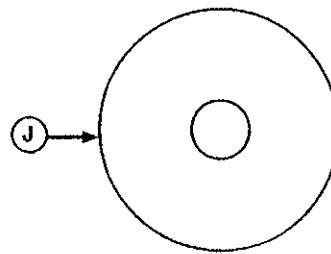
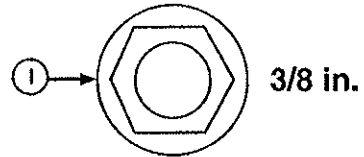
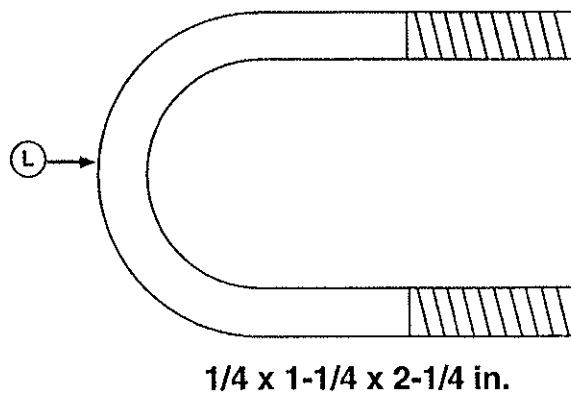
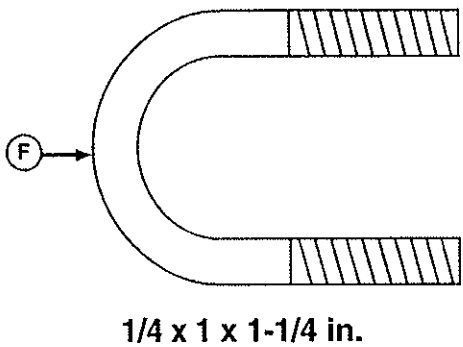
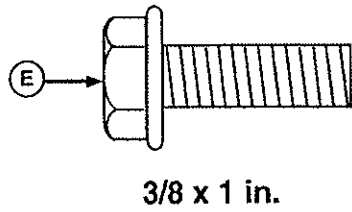
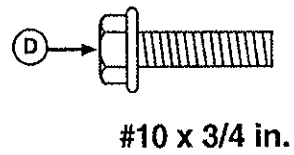
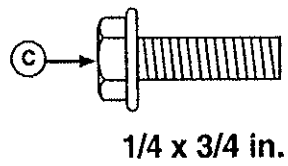
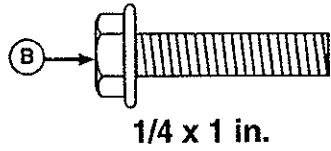
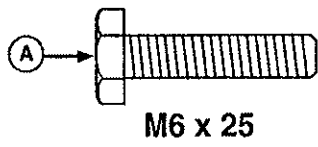

TYB3463 -19-21APR98

Pre-Installation

Facing page illustration provides full scale depiction of hardware components. The illustration can be used as a hardware identification template.

Key	Part Description/Use	Qty.
A	Bolt, M6 x 25 mm Hex Head (Door Posts)	2
B	Bolt, 1/4 x 1 in. Serrated Flange (Yoke to Door Posts)	2
C	Bolt, 1/4 x 3/4 in. Serrated Flange (Door Post to Braces, LH Door Latch)	6
D	Bolt, #10 x 3/4 in. Serrated Flange	16
E	Bolt, 3/8 x 1 in.	1
F	U-Bolt, 1/4 x 1 x 1-1/4 in. Door Post Braces	2
G	Nut, 1/4 in. Serrated Flange	14
H	Nut, #10 Serrated Flange	16
I	Nut, 3/8 in.	1
J	Washer Fender (LH Door Latch, Door Posts)	4
K	F1 Clip (Side Windows, Doors to Front Post)	12
L	U-Bolt, 1/4 x 1-1/4 x 2-1/4 in.	1

OMTYMB1.D -19-05AUG98

WINDSHIELD LAYOUT DIAGRAM

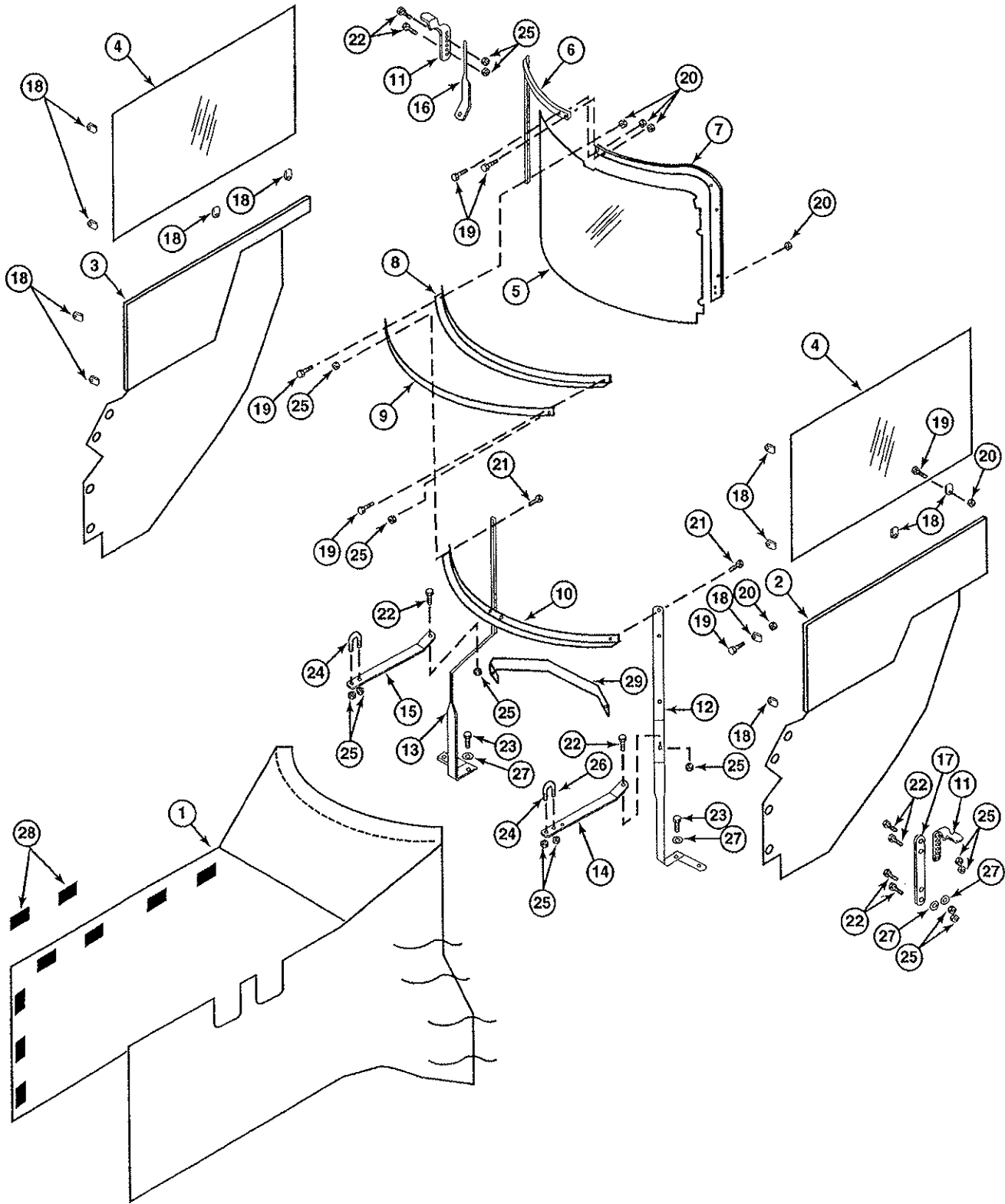

-JUN-21/APR98

TYB343B

Pre-Installation

Key	Description	Part Nos.	Qty.
1	Motor Cover	PT20159	1
2	Door, Left-Hand	PT20160	1
3	Door, Right-Hand	PT20161	1
4	Window, Side	PT19250	2
5	Windshield	PT19251	1
6	Windshield Frame, Right-Hand	PT19252	1
7	Windshield Frame, Left-Hand	PT19253	1
8	Weathershield Strip, Angled	PT19254	1
9	Weathershield Strip, Flat	PT19255	1
10	Yoke	PT19256	1
11	Door Latch	PT19257	2
12	Door Post, L.H.	PT20162	1
13	Door Post, R.H.	PT20163	1
14	Door Post Brace, L.H.	PT20164	1
15	Door Post Brace, R.H.	PT20165	1
16	Latch Bracket, R.H.	PT20166	1
17	Latch Bracket	PT19262	1
18	Clip	PT6114	12
19	Bolt, Serrated Flange, #10 x 3/4 in.	PT13015	16
20	Nut, #10	N125411	16
21	Bolt, Serrated Flange, 1/4 x 1 in.	PT12357	3
22	Bolt, Serrated Flange, 1/4 x 3/4 in.	N10216	8
23	Bolt, M6 x 25 mm	19M7286	2
24	U-Bolt, 1/4 x 1 x 1-1/4 in.	PT6135	2 (6405, 6605) 1 (7405)
25	Nut, 1/4 in.	N10217	15
26	U-Bolt, 1/4 x 1-1/4 x 2-1/4 in.	PT20167	1 (7405)
27	Washer, Fender	24H1657	4
28	Dual Lock™ Adhesive, 6 Ft. (1829 mm)	PT16387	1
29	Dash Bracket	PT20168	1

OMTYMB1,E -19-05AUG98

Installation

INSTALL DOOR POSTS

1. Remove bolt (A) from left side of tractor platform.
2. Loosely attach left door post (B) to platform using M6 x 25 mm bolt (A) and fender washer.
3. Repeat steps 1 and 2 to attach right door post.

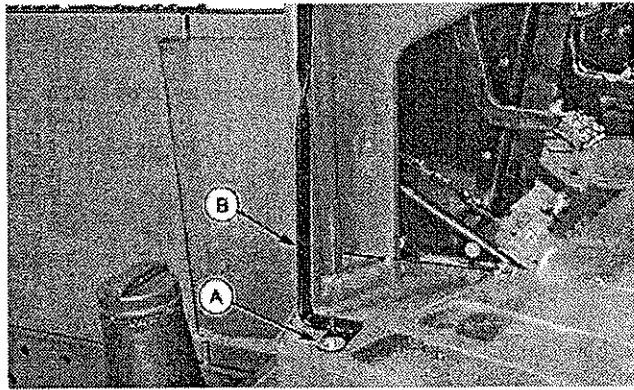

OMTYMB1,F -19-05AUG98

TYB3424 -JUN-26MAR98

INSTALL MOTOR COVER ON DOOR POST

NOTE: On tractors with vertical exhaust, remove muffler opening fabric piece (pocket) (A) (7405) or (B) (6405, 6605) from left side of cover by removing thread before installation. For 6405 and 6605, remove front fabric extensions (C) on motor cover.

To remove the thread, clip every fourth thread and pull thread from fabric.

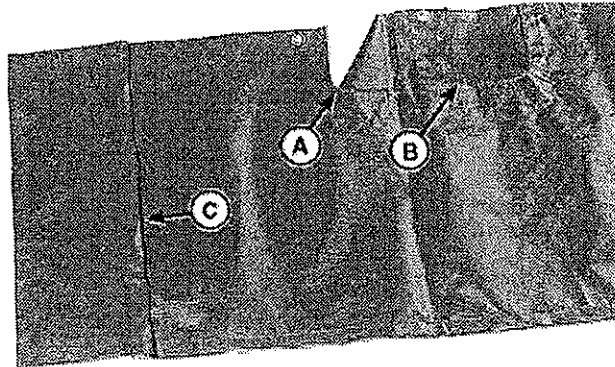

OMTYMB1,G -19-05AUG98

TYB3440 -JUN-21APR98

NOTE: Install motor cover with straps to outside as illustrated.

1. Install three inch sleeves (A) on left and right side of motor cover over door posts (B).
2. Arrange motor cover over top of hood and down sides.



OMTYMB1,H -19-05AUG98

TYB3426 -JUN-21APR98

INSTALL YOKE

1. Insert yoke (A) through top three inch sleeve (B) of motor cover.

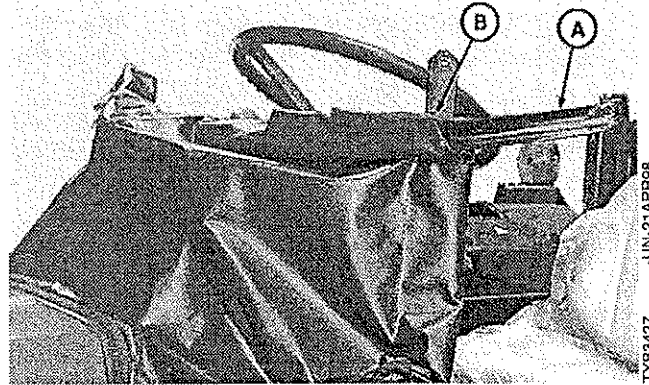

OMTYMB1,K -19-05AUG98

2. Attach yoke to left door post (A) using 1/4 x 1 in. bolt from inside with nut (B) on outside.

3. Repeat steps 1 and 2 for right door post.

4. Tighten all hardware installed up to this step.

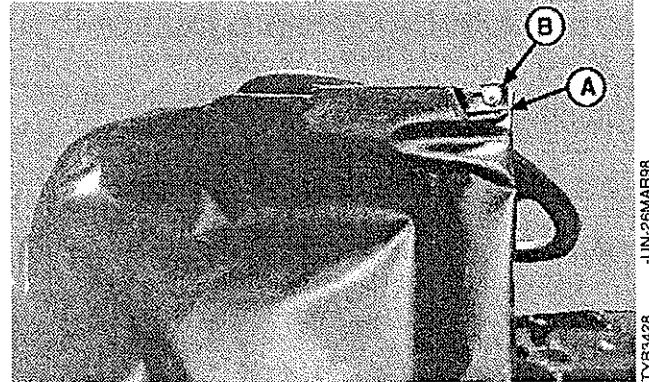

OMTYMB1,V -19-05AUG98

INSTALL DOOR POST BRACES

1. Locate hole in left door post, just below bend in post, cut bolt hole in fabric.

2. Attach bent end of brace (A) to door post using 1/4 x 1 in. bolt (B) with nut.

3. (6405, 6605) Attach flat end of brace under front grab handle (C) using 1/4 x 1 x 1-1/4 in. U-bolt (D) through two inside holes on brace (A). Repeat steps 1—3 to install right-hand brace.

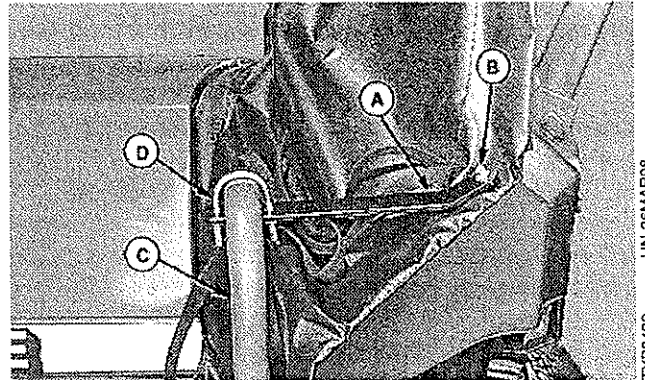

(7405) Attach flat end of brace under front grab handle (C) using 1/4 x 1-1/4 x 2-1/4 in. U-bolt (D) through two holes at end of brace (A).

- A—Brace
- B—Bolt, 1/4 x 1 in.
- C—Grab Handle
- D—U-Bolt

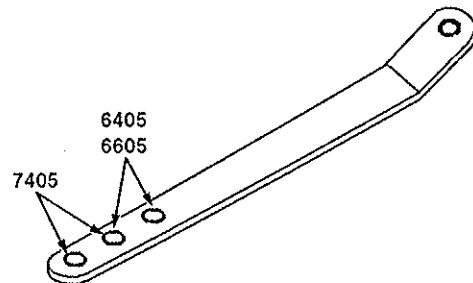

OMTYMB1,L -19-05AUG98

Installation

4. (7405) Remove dash fastener bolt. Use new 1/4 x 3/4 in. bolt (A) and nut to attach dash bracket (B) to dash.

5. Locate hole in right-hand door post, cut fabric with scissors or utility knife and attach bracket to post using 1/4 x 3/4 in. bolt (C) and nut.

6. Tighten all bolts.

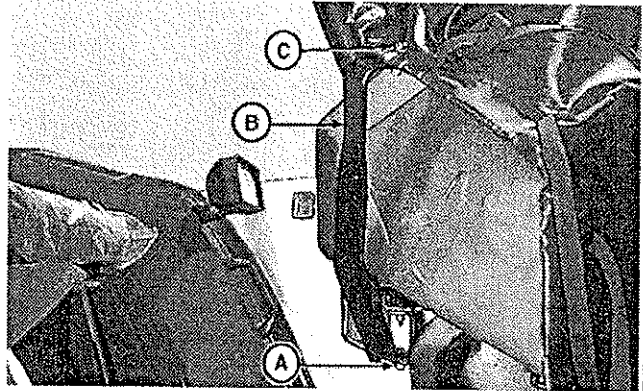

OMTYMB1.M -19-05AUG98

ATTACH MOTOR COVER DUAL LOCK™

NOTE: Do not remove backing from Dual Lock™ at this time.

1. Cut Dual Lock™ into 2 in. (51 mm) lengths.

2. Apply cut Dual Lock™ pieces (A) to all sewn Dual Lock™ pieces (B) on motor cover as illustrated.

Dual Lock is a trademark of 3M Company.

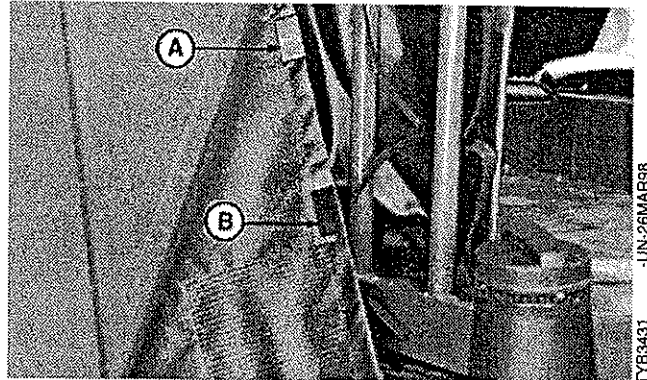

OMTYMB1.N -19-05AUG98

NOTE: Clean all painted surfaces with mild detergent to assure proper adhesion of Dual Lock™ strips.

3. Arrange motor cover (A) in proper position as illustrated.

4. Starting near door post working forward, remove backing from Dual Lock™ strips and apply to tractor, maintaining proper motor cover position.

5. Repeat for all Dual Lock™ strips on both sides of tractor.

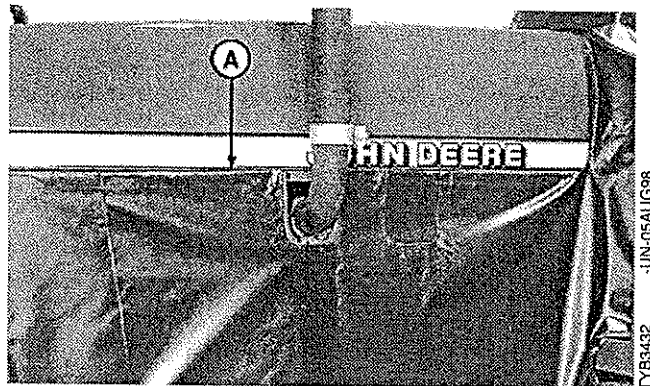

OMTYMB1.P -19-05AUG98

INSTALL WINDSHIELD ASSEMBLY

1. Attach left window frame (A) to right window frame using two #10 x 3/4 in. bolts and nuts (B).
2. Slide plastic windshield (C) into channel of windshield frame.

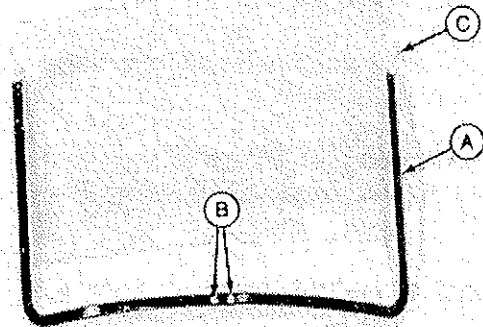

-UN-10JUN96
TYB2993

TY24012,X -19-02AUG96

3. Sandwich windshield frame between flat windshield strip (A) and angled strip (B), with flat strip in front of frame and angled strip behind it.
4. Align two bolt holes in left end of strips with two holes in bottom of left window frame.
5. Attach strips to frame using #10 x 3/4 in. bolts from inside through upper hole. Fasten with nuts (C).
6. Repeat for right end of strips.

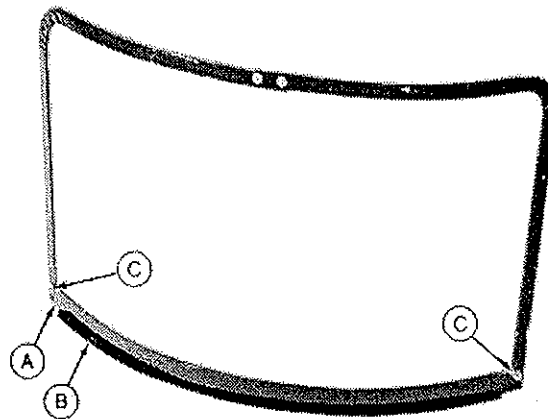

-UN-06JUN96
TYB2994

TY24012,Y -19-02AUG96

TIGHTEN ALL BOLTS.

7. Remove nuts (A) holding each end of yoke to door posts.
8. Install windshield assembly using existing 1/4 x 1 in. bolts holding yoke to door posts. Fasten with nuts (A) removed in previous step.

TIGHTEN ALL BOLTS.

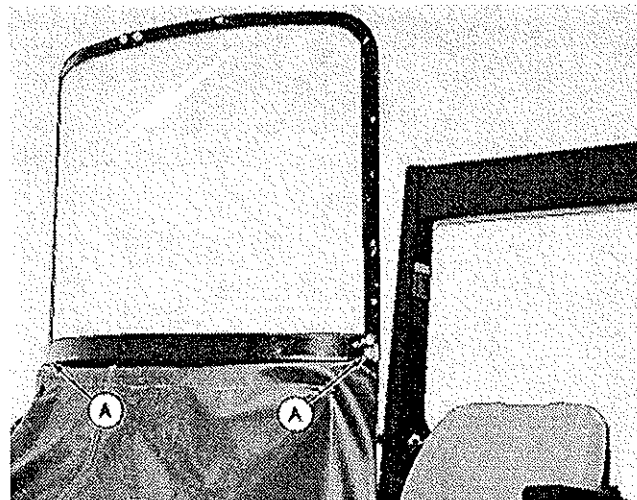

-UN-21APR98
TYB2995

OM24536,A -19-05AUG98

INSTALL DOORS

1. Locate bolt holes in left door post (A) under fabric. Cut bolt holes in fabric.
2. Hold front edge of left door (B) along door post. Align top edge of door with bottom of windshield assembly as shown.
3. Mark door post hole locations on front edge of door.
4. Using door marks as guides, cut 5/8 in. vertical slots in door fabric BEHIND WIRE DOOR FRAME.
5. Insert clips (C) through 5/8 in. slots and around wire frame.
6. Align clips with door post holes and fasten using #10 x 3/4 in. bolts and nuts.

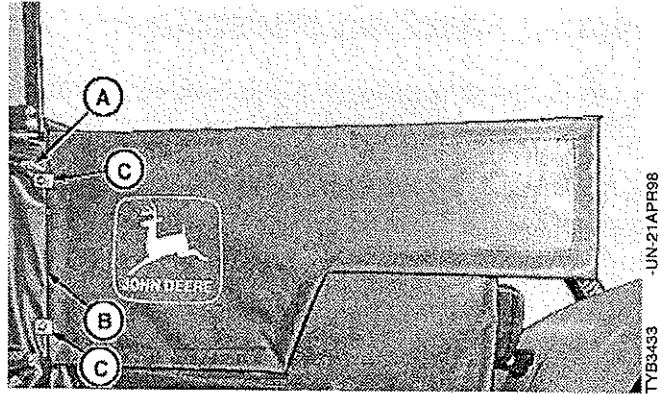

OMTYMB1,15A -19-05AUG98

7. Insert straps on motor cover through eyelets (A) on door and tie.
8. Repeat steps 1 through 7 for right door.

TIGHTEN ALL BOLTS.

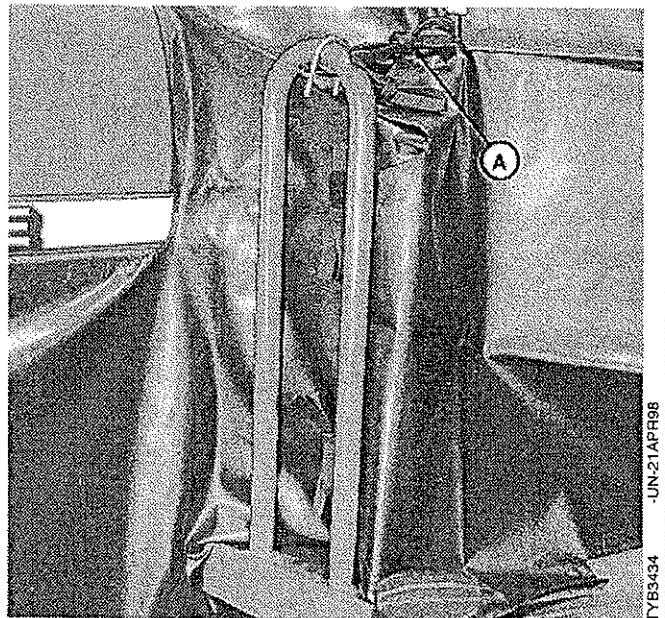

OMTYMB1,15B -19-05AUG98

INSTALL SIDE WINDOW

1. Hold side window (A) with one edge along left windshield frame, another edge along top of left door (B) as shown.
2. Mark location of holes in windshield frame on front edge of side window.
3. Using marks as guides, cut 5/8 in. vertical slots in side window behind wire window frame.
4. Insert two clips (C) through slots around wire.
5. Align clip holes with holes in windshield frame. Fasten using two #10 x 3/4 in. bolts and nuts.
6. Cut 5/8 in. horizontal slot at center and rear above lower wire frame of window at (D).
7. Insert clips through each slot around wire frame in window.
8. Mark location of clip holes on top of door fabric below door wire, cut bolt holes in door fabric.
9. Attach window to door using #10 x 3/4 in. bolt with nut for each clip.
10. Repeat steps 1 through 9 for right door.

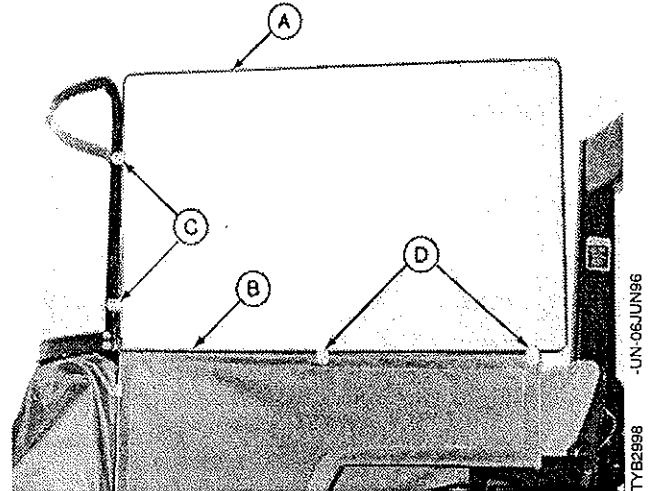

TYB2958 -UN-06JUN96

TIGHTEN ALL BOLTS.

OMTYMB1,Q -19-05AUG98

INSTALL DOOR LATCHES

1. Attach left-hand door latch (A) to latch strap (B) using two 1/4 x 3/4 in. bolts with nuts.

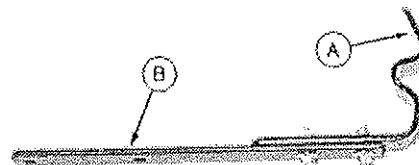

-UN-06JUN96

TYB3000

TY24012,AE -19-02AUG96

Installation

NOTE: Operators manual compartment must be removed on 7405 Tractors to install door latch assembly.

2. Position door latch assembly (A) on fender so left door (B) catches in latch when closed.
3. Mark location of two bottom bracket holes on left fender.
4. Drill two 9/32 in. holes in fender at bolt marks.
5. Attach door latch to fender using two 1/4 x 3/4 in. bolts (C) with fender washers and nuts.
6. On 7405 Tractors, reinstall operator manual compartment.
7. Tighten all bolts.

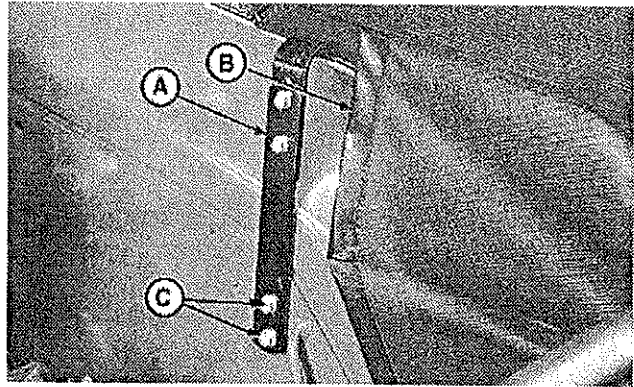

TYB3436
-UN-21APR98

OMTYMB1,S -19-05AUG98

INSTALL RIGHT-HAND DOOR LATCHES

1. Install right-hand latch (A) to latch strap (B) using two 1/4 x 3/4 in. bolts and nuts.
2. Remove work light if equipped.
3. Position latch assembly on fender worklight fastener through latch bolt hole, reinstall worklight.
4. If no worklight, use 3/8 in. bolt provided to attach latch assembly to fender.

NOTE: If door contacts shift knob, rotate latch outward to provide additional clearance.

5. Tighten all bolts.

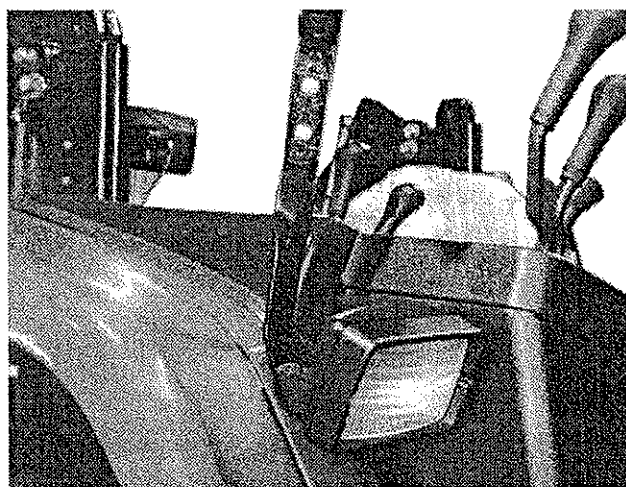
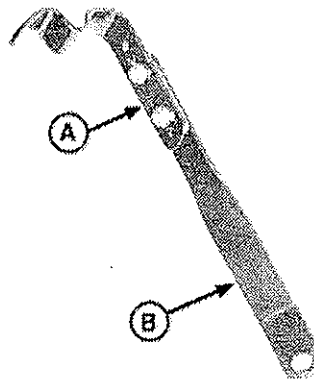

TYB3437 -UN-26MAR98

TYB3436 -UN-26MAR98

OMTYMB1,T -19-05AUG98

Warm Weather Operation

WARM WEATHER CONVERSION

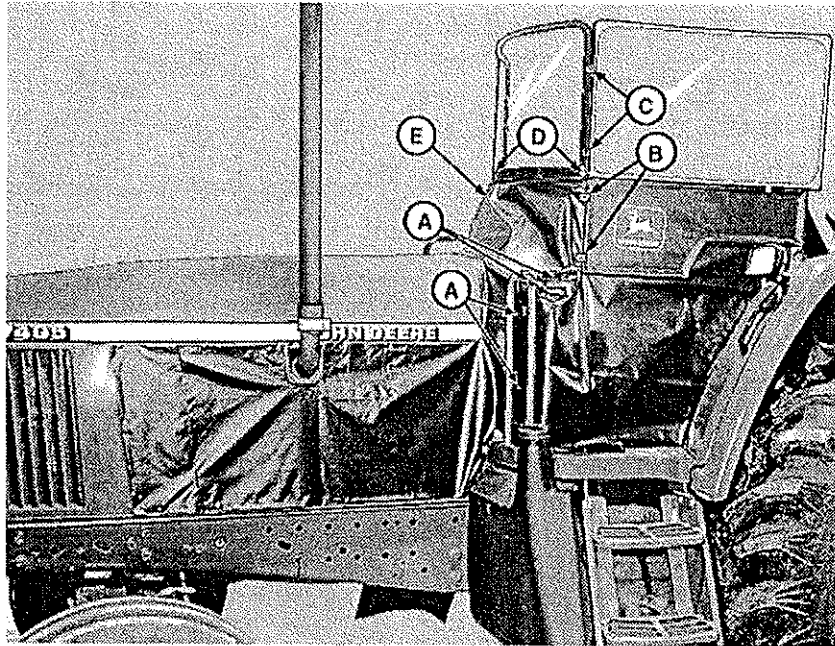

A—Motor Cover Straps
B—Bolt, #10 x 3/4 in. (2 used)

C—Bolt, #10 x 3/4 in. (2 used)

D—Bolt, 1/4 x 1 in. (2 used)

E—Motor Cover Sleeve

NOTE: Doors, side windows and motor cover can be easily removed for warm weather operation.

1. Untie motor cover straps (A) and remove from eyelets on left door.
2. Remove two #10 x 3/4 in. bolts (B) holding left door to front post.
3. Remove two #10 x 3/4 in. bolts (C) holding side window to windshield assembly. Remove left door side window assembly with four clips.

NOTE: Reinstall #10 bolts in clips to prevent loss of hardware.

4. Repeat steps 1 through 3 for right-hand door side window assembly.

5. Unfasten straps holding left and right side of bottom edges of motor cover.

6. Separate Dual Lock™ strips holding left and right side of motor cover to tractor.

7. Remove two 1/4 x 1 in. bolts (D) holding windshield assembly, yoke to front posts.

8. Remove yoke from top sleeve (E) of motor cover.

9. Reinstall yoke, windshield assembly on front post using two 1/4 x 1 in. bolts removed in step 7.

NOTE: Do not store removed Weathershield parts where water may accumulate or where parts may be soiled/damaged by birds or rodents.

OMTYMB1.W -19-05AUG98

Weathershield Care

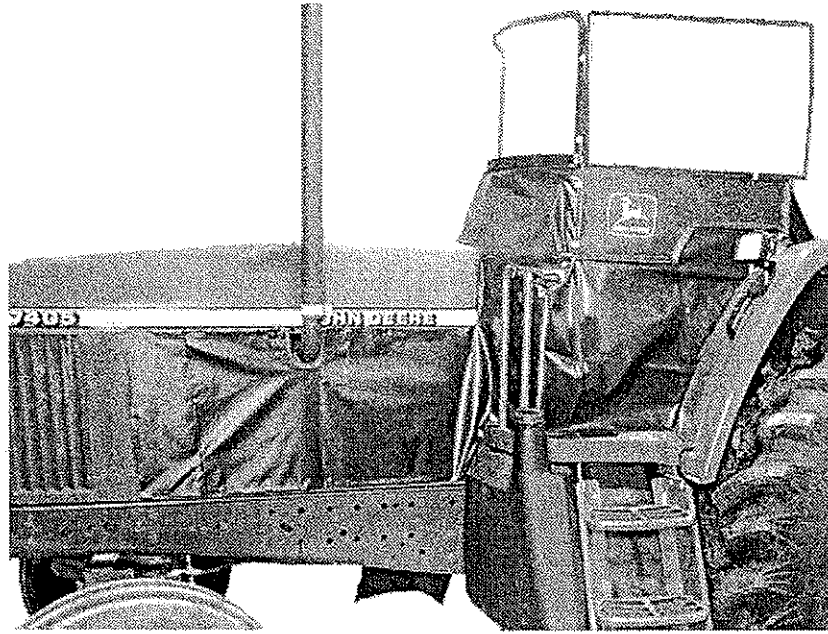

TY83439 -UN-26MAR96

OMTYMB1,25A -19-05AUG98

KEEP HARDWARE TIGHT

IMPORTANT: After every 50 hours of service, ensure hardware is tight.

TY24012,AJ -19-02AUG96

CLEAN WEATHERSHIELD

IMPORTANT: DO NOT rub plastic windows even with damp cloth. Use water only. Surface is easily scratched.

1. To clean windows, flush with water.
2. Clean door and curtain fabric with common automotive vinyl cleaner or mild detergent.

TY24012,AK -19-02AUG96

Contents

	Page
Safety	05-1
Pre-Installation	
Tractor Configuration	10-1
General Information	10-2
Tools Required	10-2
Prepare Enclosure	10-3
Prepare Tractor	10-3
Hardware Components	10-4
Windshield Layout Diagram	10-6
Installation	
Install Door Posts	15-1
Install Motor Cover on Door Post	15-1
Install Yoke	15-2
Install Door Post Braces	15-2
Attach Motor Cover Dual Lock™	15-3
Install Windshield Assembly	15-4
Install Doors	15-5
Install Side Window	15-6
Install Door Latches	15-6
Install Right-Hand Door Latches	15-8
Warm Weather Operation	
Warm Weather Conversion	20-1
Weathershield Care	
Keep Hardware Tight	25-1
Clean Weathershield	25-1

Index

All information, illustrations and specifications in this manual are based on the latest information available at the time of publication. The right is reserved to make changes at any time without notice.

OMTY24536 H8-19-05AUG98

COPYRIGHT© 1998
DEERE & COMPANY
Moline, Illinois
All rights reserved
A John Deere ILLUSTRATION™ Manual