



www.femcomfg.com

2021 PRODUCT CATALOG



Enclosures, Weather Brakes, Sunshades & Umbrellas



ROPS & Canopies

GENERAL OFFICES
1132 WEST 1ST STREET
McPherson, KS 67460
Toll Free: 1-800-677-0898
Fax: (620) 241-3532
Web: www.femcomfg.com
Email: femco@femcomfg.com

*Specializing in Weather &
Safety Protection*

FEMCO, INC. GENERAL POLICIES

PRICING: Prices are as stated on current price sheets and are subject to change without notice.

SHIPPING & HANDLING: When possible, we will ship via UPS to reduce freight costs. However, due to extra labor involved in weighing and stamping, a shipping and handling charge of \$4.00 will be added to all UPS Shipments. For UPS 100wt, an additional charge of \$10.00 will be added (200lb. minimum). Items shipping via a truckline will ship freight collect only.

TERMS: Terms are Net 30 days with approved credit. Please pay by invoice – no statement will be sent. A charge of 1.5% per month (annual percentage rate of 18%) will be charged on unpaid balances. Those customers requesting an open account may do so and ship current shipments COD until your account has been approved.

Government Purchase Orders: Femco, Inc. must receive payment before product will be sent on all government orders. Payment can be paid by Visa or Master Card.

FEMCO, INC.: Warranty on products is 90 days from the date of purchase. This warranty is on workmanship and materials only. This warranty is limited to replacement of “defective” parts only and does not cover any labor charges to remove or reinstall part(s). To prevent shortages, all packages are sealed with pilfer-proof tape and electronically weighed.

DAMAGE: We package our products according to carrier and manufacturer standards. Please be alert for shipping or hidden damage and file your freight claims at once. Once the carrier accepts the shipment, the responsibility for damage or loss becomes that of the carrier. If packages arrive in a condition that could conceal damage or loss of parts, write on the Bill of Lading that the shipment has been received subject to inspection of contents. This will help expedite your claim with the carrier.

RETURNS: A “Return Goods Authorization” (RGA) number, issued by FEMCO prior to shipping, must be marked on the outside of each package and must arrive at our location within 15 days of RGA issuance or item(s) will not be accepted. The returned item must have been purchased within the last 30 days, be in sellable condition, and contain all parts. You will be responsible for any missing/damaged parts. You must prepay the freight on the returned item and a 20% restocking charge will be applied to returned merchandise.

SHORTAGE: To expedite a shortage, please have the following information

1. FEMCO product number
2. Missing part number and description
3. Femco’s invoice number
4. Date code on the end of the shipping carton.

PLEASE CAUTION YOUR CUSTOMERS TO READ THE INSTALLATION INSTRUCTIONS CAREFULLY BEFORE THEY BEGIN TO ASSEMBLE IN ORDER TO PREVENT DAMAGE TO PARTS USED IN ERROR



GENERAL OFFICES
1132 W. 1ST STREET
McPherson, KS 67460
Phone: 1-800-677-0898
Fax: (620) 241-3532
Web: www.femcomfg.com

R.O.P.S.

(Roll-Over Protective Structure)

For John Deere Gators™ ONLY



www.femcomfg.com

301013824

MADE IN U.S.A.

- R.O.P.S. meets or exceeds requirements of 29CFR1928.52 (OSHA) and SAE J1194
- Seat Belts are provided for both occupants
- Attractive Styling
- Powder coat finish
- All mounting hardware is plated and included
- Cargo screen is included to eliminate finger pinch point and protect the operator from load transfer
- Easily installed
- Installation and Parts Manual is included
- Fits: Old Style 6 x 4, 4 x 2, TH, TS, TX, M-1, Worksite & TE (TE ONLY if you re-locate the plug)

TO INSURE OCCUPANT SAFETY, SEAT BELTS MUST BE WORN AT ALL TIMES!!

FEMCO, Inc.

SAFETY FIRST

1132 W. 1ST STREET

McPherson, KS 67460

800-677-0898

620-241-3532 Fax

e-mail: femco@femcomfg.com

Gator™ is a registered trademark of Deere and Company

SNAP-IN WINDSHIELD

Part Number 3282

FOR THE JOHN DEERE GATOR 4 X 2 AND 6 X 4

NEEDS: 3278 CANOPY TO FIT WINDSHIELD ON UNIT



GENERAL OFFICES
1132 W. 1ST STREET
McPherson, KS 67460
Phone: (620) 241-3513
Fax: (620) 241-3532
Toll Free: 1-800-677-0898
Web: www.femcomfg.com
Email: femco@femcomfg.com

FEMCO'S NEWEST "T-SERIES" GATOR WINDSHIELD

306023727

(Fit's TH, TS, TX Gators Only. Requires 301013824 ROPS & 312013679 Canopy)



For pricing and availability please call 1-800-677-0898
www.femcomfg.com

FEMCO, INC
1132 W. 1ST STREET
McPherson, KS 67460

Items in Red are Obsolete

+ = REAR ENTRY

* = ITEMS WILL BE OBSOLETE ONCE INVENTORY IS DEPLETED

VINYL PN	ALLIS CHALMERS WITH/WITHOUT 2 POST ROPS	FRONT WINDSHIELD ONLY	FRONT WINDSHIELD GLASS AND FRAME ONLY	SIDE WINDOWS 30502		OPTIONAL TOP
				LS	RS	
307020900+*	WD & WD45 (REAR ENTRY)(GREEN)	305021225	305021209	1213	1213	N/A
307021122*	D-17 (1958-59-60-61 & 62 GAS)(GREEN)	305021225	305021209	1212	1213	N/A
307021186*	D-17 SERIES III & IV (GAS & DIESEL)(GREEN)	305021225	305021209	305021243	1213	N/A
307021411*	180 & 185 (GAS & DIESEL)(GREEN)	305021225	305021209	1212	1213	N/A
307021412*	170 & 175 (GAS & DIESEL)(GREEN)	305021225	305021209	1212	1213	N/A
307021422*	190, 190XT, & 200 (GAS, DIESEL & LPG)(GREEN)	305021225	305021209	1212	1213	N/A
CASE WITH/WITHOUT 2 POST ROPS						
307021338*	930, 931(DIESEL), 940, 941 (GAS & LPG) (SERIAL #8253501 AND UP), 1030, 1031 DIESEL(GREEN) OBSOLETE	305021225	305021209	1212	1213	N/A
307021341	731, 741C(DIESEL), 741, 841, 841C(GAS), 730 & 830(SERIAL #8253501 & UP) OBSOLETE	305021225	305021209	1212	1213	N/A
307021432*	770, 870, 970, 1070, 1170, 1175 ROW CROP (GAS & DIESEL)(GREEN)	305021225	305021209	1246	1289	N/A
307021485	1490, 1690 LOW PLATFORM (OBSOLETE)	305021226	305021210	1246	1289	N/A
307052286*	C SERIES (BLACK VINYL)	305021226	305021210	1246	1289	N/A
307052287*	CX SERIES (BLACK VINYL)	305021226	305021210	1246	1289	N/A
CASE IH WITH/WITHOUT 2 POST ROPS						
307022104*	5120,5130,5140 (MAXXUM) (WITH/WITHOUT LOADER)(RED)	305021226	305021210	1246	1246	N/A
CASE/DAVID BROWN WITH/WITHOUT 2 POST ROPS						
307021451*	880,885,990,995,4600(1965 TO DATE)(GREEN)	305021226	305021210	1212	1213	N/A
CENTURY/BRANSON WITH/WITHOUT 2 POST ROPS						
307022150*	CENTURY MODELS 2028, 2535, 3035, 3040, 3045 CENTURY WILL NOT WORK WITH LOADERS. BRANSON: 2910i, 3820i, 4220i, 4720i, BL20A LOADER, 3510i, BL10A(BLACK)	305021226	305021210	1248	1248	N/A
JOHN DEERE WITH/WITHOUT 2 POST ROPS UNLESS INDICATED						
307020982+*	50,60,70,520,620,720(DISTILLATE & GAS) REAR ENTRY(GREEN)	305021225	305021209	1213	1213	N/A
307021094+*	530,630,730(LPG, GAS, DIESEL) WITH ELECTRIC STARTER REAR ENTRY(GREEN)	305021225	305021209	1213	1213	N/A
307021317+*	2510,2520,3010,3020,4000,4010,4020,4320,(2510,2520 REQUIRES KIT#1278 TO INSTALL REAR ENTRY)(NOT CUT) 2003 MODEL YEAR)(GREEN) (NOT CUT)	305021225	305021209	1213	1213	N/A
307021425*	4520,4620 (GAS, DIESEL, LPG)(GREEN)	305021225	305021209	1212	1213	N/A
307021436	2510,2520,3010,3020,4000,4010,4020,4320 (2510,2520 REQUIRES KIT #1278 TO INSTALL) (NOT CUT) COMPACT 2003 MODEL YEAR)(GREEN)	305021225	305021209	1212	1213	N/A
307021443*	4030,4040,4050,4055,4230,4240,4250,4255,4430, 4440,4450,4455,4555,4630,4640,4650,4755 FOR TRACTORS WITHOUT 4-POST ROPS AND RIGID STEERING COLUMNS ONLY(GREEN)(NOT CUT)	305021225	305021209	1212	1213	N/A
307021470	820, 830, 920, 1020, 1140, 1840, 2050, 1120, 1520, 1530, 2020, 2030, 2120, 2630(RU,HU,LU) 1030, 1630, 1830 & 1976 MODELS: 2040, 2240, 2440 & 2640 NEW GENERATION MODELS: 1140, 1840, 2050, 2150, 2155, 2350, 2355, 2550, 2555, 2750, 2755 LOW PLATFORM MODELS; CANADIAN 1130 WILL NOT FIT 140 LOADER WILL NOT WORK WITH LOADERS WITH JOYSTICK CONTROL LEVERS BUT IS OK WITH 2 SPOOL VALVE CONTROLS LOCATED AT OR BELOW TOP OF HOOD (GREEN)	305021225	305021209	305021243	1213	N/A

307021471*	1050(GREEN)	305021225	305021209	1246 1289	N/A
307021475	2840,2940,2950(2955 W/RIGID STEERING ONLY) CANADIAN 3130,3140(GREEN)	305021225	305021209	1246 1289	N/A
307021476*	2750 2755 HIGH PLATFORM(GREEN)	305021225	305021209	1212 1213	N/A
307021477*	850, 950 UP OR DOWN EXHAUST & POWER STEERING (GREEN)	305021225	305021209	1246 1289	N/A
307021482	750, 650 UP EXHAUST (GREEN) OBSOLETE	305021225	305021209	1246 1289	N/A
307022008*	655, 755, 855 (GREEN)	305021226	305021210	L720599700 R720599700	N/A
307022022*	2955,3150,4030,4040,4050,4055,4230,4240,4250,4255, 4430,4440,4450,4455,4555,4630,4640,4650,4755 WITH 4 POST ROPS AND JD CANOPY RE 19445 (GREEN) OBSOLETE	305023600 (2)	N/A	N/A	
307022097*	870 970 1070 (with/without loader (GREEN)	305021225	305021209	1246 1289	N/A
307022125	5200,5300,5400,5500(2WD OR 4WD W/WO JD 500 SERIES LOADER)5210,5310,5410 (CUT)(NOT NARROW SERIES) (NOT 5510 OR 20 SERIES)(BLACK)	305021226	305021210	1246 1289	N/A
307022131*	6000 SERIES, 6200, 6300 & 6400 HIGH & LOW PLATFORM (NOT 10 OR 20 SERIES) (BLACK)	305021226	305021210	1248 1248	N/A
307022141	4200, 4300, 4400, 4500, 4600, 4700,4210, 4310, 4410, 4510, 4610, 4710 (CUT OK FOR ALL LISTED HERE) W/WO LOADER (BLACK)	305021226	305021210	1248 1248	N/A
307022143*	JD ADVANTAGE SERIES 6405, 6605, 7405 (BLK)	305021226	305021210	1248 1248	N/A
307022146*	2210 BLACK VINYL ONLY (NOT THE 2305)	305021226	305021210	1248 1248	N/A
307022147*	JD 4100 (BLK VINYL ONLY) NOT 4110	305021226	305021210	1248 1248	N/A
307022161*	5320, 5220(NOT NARROW SERIES), BLK VINYL, UP/DOWN EXHAUST(NOT HIGH PLATFORM, WORKS ON STRADDLE MOUNT/LOW PLATFORM) YEAR 2005 OR OLDER ONLY	305021226	315021210	1248 1248	N/A
307022176	JD 3120,3320,3520,3720(W/WO 300X LOADER)(CUT)(BLK)	305021226	305021210	1248 1248	N/A
307022529	JD 5103, 5203, 5303 & 5403(NOT 5603) WORKS WITH JD MODEL 522 LOADER ONLY (BLACK)	305021226	305021210	1248 1248	N/A
307022552*	5105, 5205 (BLACK) W/ OR W/O LOADER 2/4WD(CUT) (OBSOLETE)	305021226	305021210	1248 1248	N/A
	FORD WITH/WITHOUT 2 POST ROPS	NEW HOLLAND			
307020914*	8N (NOT ON JUBILEE)(BLUE)	305021225	305021209	1212 1213	N/A
307021080	600, 800(ALL), 2000, 4000 ALL PURPOSE 1964 & PRIOR (BLUE) OBSOLETE	305021225	305021209	1212 1213	N/A
307021457	2000, 2100, 2600, 3000, 3100, 3600, 4000SU, 4600SU, ALL PURPOSE 1965 & UP(BLUE)	305021225	305021209	1247 1247	N/A
307021458	5000, 5100, 5600(LA-1), 6600(EA-1), 7000, 7100, 7600(FA- 1) ALL PURPOSE (BLUE) ONLY WORKS WITH FLAT FENDERS WILL NOT WORK WITH SHELL FENDERS, WILL NOT WORK WITH HIGH PLATFORM	305021225	305021209	L305025125 R305025126	N/A
307021459*	4000, 4100, 4600 (DA-1 ALL PURPOSE)(BLUE)	305021225	305021209	L305025125 R305025126	N/A
307021467*	6700, 7700, TW10, TW20(FLAT DECK OR ROW CROP) (BLUE) OBSOLETE	305021225	305021209	1246 1246	N/A
307022101*	1720, 1920,(W/WO LOADER)(NOTW/SHUTTLE TRANS. UNLESS SHIFTER IS ON THE DASH AND TO THE LEFT) (BLUE) OBSOLETE	305021226	305021210	1246 1246	N/A
307022121*	5640, 6640, 7740(S,SL) W/WO LOADER 7411 LOADER (LOW PLATFORM ONLY) (BLUE)	305021226	305021210	1248 1248	N/A
307022136*	3430, 3930, 4630, 5030(W/WO LOADER, SHELL OR HIGH TOP FENDERS) (BLUE)	305021226	305021210	1248 1248	N/A
307022142	TC25/25D, TC29/29D, TC33/33D, TC35/35D, TC40/40D, TC45/45D(W/WO LOADER)NOT DA) DX IS OK (BLACK)	305021226	305021210	1248 1248	N/A
307022145	TN65, 70, 75, TN55D, TN55S, TN65D, TN75D, TN75S (BLACK) DOES NOT WORK WITH TN-DA, TN-SA OR TN-FA	305021226	305021210	1248 1248	N/A

307022178*	TL80A, TL90A, TL100A W/WO LOADER (BLACK)	305021226	305021210	1248 1248	N/A
	INTERNATIONAL WITH/WITHOUT 2 POST ROPS				
307021012+	M & SUPER M, MD & SUPER MD, SUPER MTA, MDTA & SUPER MDTA, 350, 400, 450(DIESEL & GAS) (RED)	305021225	305021209	1213 1213	N/A
307021072+	F460, F560 (GAS & DIESEL & LPG) (RED)	305021225	305021209	1213 1213	N/A
307021331	F706, F806, F1206(GAS, DIESEL, LPG) NOT FLAT FENDERS (CROWN FENDERS OK) (RED)	305021225	305021209	1212 1213	N/A
307021421	F544, F656, F666, F686, HY-DRO 70, 86 INCLUDES HYDROSTATIC & HI-CLEAR (GAS & DIESEL) (RED)	305021225	305021209	1212 1213	N/A
307021429	F756, F826, F856, F1026, F1256, F1456, INCLUDES HYDROSTATIC (GAS & DIESEL) (RED)	305021225	305021209	1246 1289	N/A
307021439	F766, F966, F1066, F1466, F1566, HYDRO 100 INCLUDES HYDROSTATIC (GAS & DIESEL) NOT 4-POST ROPS (RED)	305021225	305021209	1246 1289	N/A
307021440*	I-454, I-464, I-574, I-674 INCLUDES HYDROSTATIC (GAS & DIESEL) (RED)	305021225	305021209	L305025125 1289	N/A
307022005	I-484, I-584, I-684, I-784, H84, 884, 485, 585, 685, 885, 895 (NOT 695) (RED)	305021225	305021209	1246 1289	N/A
307022234*	F504 GAS OR DIESEL OBSOLETE	305021225	305021209	1212 1213	N/A
307022274*	I-786 (OBSOLETE)	305021225	305021209	1246 1246	N/A
307052235*	I-504, 2504(GAS & DIESEL) W/WO LOADER. (OBSOLETE)	N/A	N/A	1212 1213	N/A
	LAWN & GARDEN UNIVERSAL				
307022003*	FITS 16 TO 19 HP MUST HAVE FLAT FENDERS & FOOTRESTS. SINGLE BRAKE PEDAL. NO LEVERS OR BOXES ON FENDERS. NOT THE JD 318, 332, 400 (BLACK)	305021226	305021210	1247 1247	INCLUDED
	MASSEY FERGUSON WITH/WITHOUT 2 POST ROPS				
307021187*	50, 65 (MATIC ROW CROP OR HI-ARCH) (GAS, DIESEL, LPG) (RED)	305021225	305021209	1212 1213	N/A
307021345*	135, 2135 (GAS, DIESEL, SHELL FENDERS ONLY) (RED)	305021225	N/A	N/A	N/A
307021370*	165 ROW CROP & STD W/UPRIGHT EXHAUST FRONT OF MANIFOLD(GAS, DIESEL) FLAT FENDERS ONLY (RED)	305021225	305021209	1212 1213	N/A
307021372*	180 ROW CROP W/UPRIGHT EXHAUST FRONT OF MANIFOLD (GAS, DIESEL) (RED) (OBSOLETE)	305021226	305021210	1246 1246	N/A
307021455*	255, 265, 275, 285 (GAS, DIESEL, UP OR DOWN EXHAUST) (RED)	305021225	305021209	L305025125 R305025126	N/A
307022000*	240, 250 2 DOOR (RED)	305021226	305021210	1246 1246	N/A
307022095*	362, 375, 383, 390, 398 W/WO LOADER UP EXHAUST ONLY ON LEFT SIDE(RED)	305021226	305021210	L305025125 R305025126	N/A
307022124*	1125, 1140, 1145, 1240, 1250, 1260, 1433V, 1140V, 1433, 1440, 1429(W/WO LOADER 1246), AGCO ST35x, ST40x, ST35 W/ L SERIAL # & UP, CHALLENGER MT265, MT275, MT285(W/WO LOADER) NOT ISOLATED DECK, NOT 1155/1455 (BLACK)	305021226	305021210	1248 1248	N/A
307022172*	AGCO GT SERIES (307425330 AGCO#) (BLACK)	305021226	305021210	1248 1248	N/A
307022173*	MT295, MT297, MF1445, MF1455 & ST45 (307425331) (BLACK)	305021226	305021210	1248 1248	N/A
307022174*	FITS 431, 461 (AGCO # 307425333) (RED)	305021226	305021210	1248 1248	N/A
307022175*	MF1533, 1540, 1635, 1643, 1648, 1652, 1655, 1660, AGCO ST34A, ST41A, CHALLENGER, MT265B, MT275B, MT285B (W/WO ML 40B LOADER) (BLACK)	305021226	305021210	1248 1248	N/A
307065295*	360 (W/WO LOADER) (VERTICAL OR HORIZONTAL EXHAUST)	305021226	305021210	L305025125 R305025126	N/A
	MINNEAPOLIS MOLINE, OLIVER, WHITE, COCKSHUTT WITH/WITHOUT 2 POST ROPS				
307021081+*	OLIVER-77, 88, 770, 880, COCKSHUTT 700 (ROW CROP) (GAS & DIESEL) (GREEN)	305021225	305021209	1213 1213	N/A

307021325*	OLIVER & COCKSHUTT 1750, 1800, SERIES C, 1850, 1950 ROW CROP (GAS & DIESEL) (ADJ. STEERING WHEEL) (GREEN) OBSOLETE	305021225	305021209	1212 1213	N/A
307021460*	OLIVER & COCKSHUTT - 1550, 1555, 1600, 1650, 1655; WHITE - 2- 70; MINN.MOLINE- G-550, G-750(STD & FUEL TOP FENDERS) (GREEN)	305021225	305021209	1212 1213	N/A
307021461*	OLIVER & COCKSHUTT - 1755, 1855, 1955(ROW CROP); WHITE - 2-85, 2-105; MIN.MOLINE - G850, G940(STD. & FUEL TOP FENDERS) (GREEN) OBSOLETE	305021225	305021209	1246 1289	N/A
307022103*	WHITE -60 & 80 HP AMERICAN SERIES (W/WO LOADER) (BLACK)	305021226	305021210	1246 1289	N/A
KIOTI WITH/WITHOUT 2 POST ROPS					
307022134*	3054 W/WO LOADER	305021226	N/A	N/A	N/A
KUBOTA					
307552123	L2900, L3010, L3300, L3410, L3600, L3710, L4200, L4310, L4610, GRAND L SERIES (WORKS W/KUBOTA LOADER ONLY) ORANGE VINYL	305021226	305021210	1248 1248	N/A
307022144*	M4900, M5700, M6800, M8200, M9000, M5700SDN, M8500SDNB(WITH KUBOTA LOADER ONLY) (ORANGE) (OBSOLETE)	305021226	305021210	1248 1248	N/A
307022185	"B" SERIES: B7410, B7510, B7610, B7800, B2630 (BLACK)	305021226	305021210	1248 1248	N/A
307022186	"BX" SERIES: BX1500, BX1830, BX1860, BX2230, BX2350, BX2360 AND BX2660 NOT BX23, NOT BX24 (BLACK)IF LOADER VALVE IS ON LOADER STANTION IT WILL REQUIRE MAJOR MODIFICATIONS (OBSOLETE)	305021226	305021210	1248 1248	N/A
ZETOR					
307872151	3320, 3340, 4320, 4340, 6320, 6340, 7320, 7340, VINYL) OBSOLETE (BLACK	305021226	305021210	1248 1248	N/A
307872152	3321, 3341, 4321, 4341, 6321, 6341, 7321, 7341 VINYL) OBSOLETE (BLACK	305021226	305021210	1248 1248	N/A

DESCRIPTION

UNIVERSAL WEATHER BRAKE FIT CHART

NOTE: IF exhaust is outside of hood a guard (not provided) will need to be fabricated to prevent contact with the motor cover

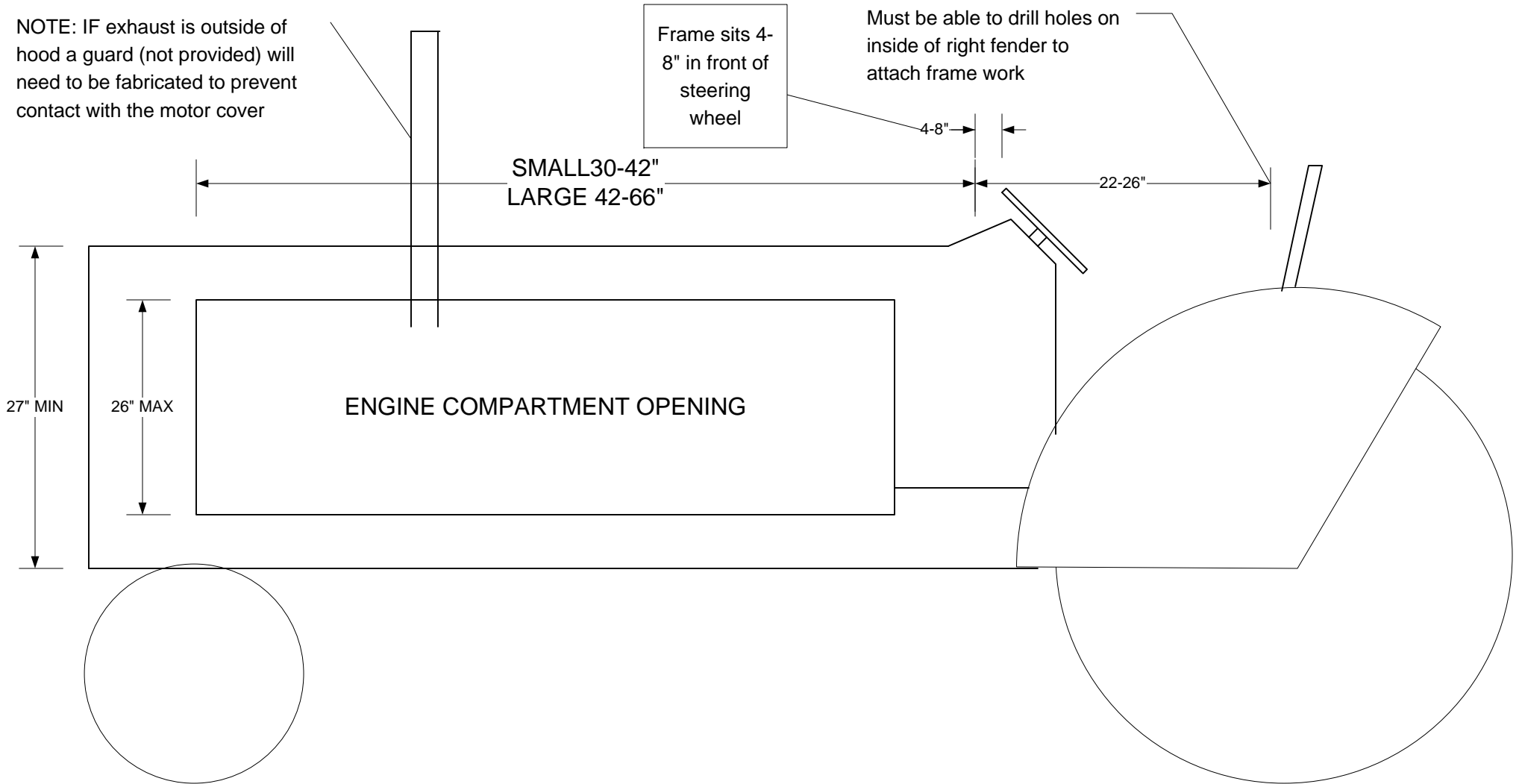

FEMCO

UNIVERSAL



WEATHER BRAKE

Three Universal Models Fit Over 300 Tractors
KEEPS YOU WARM WHEN COLD WINDS BLOW!

VINYL

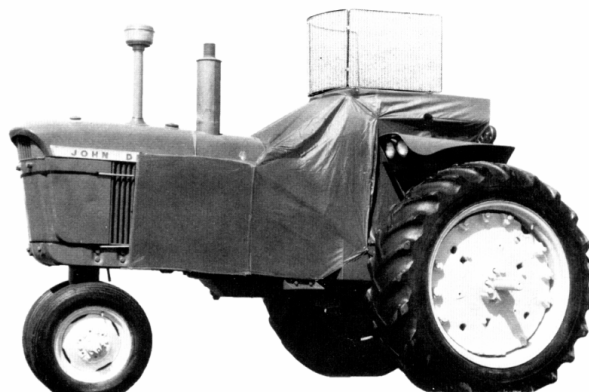

Installs Easily and Quickly - Built-In Value - Heavy Vinyl Cover - Adjustable Window Flaps - Heavy Gauge Steel Frame - Big 3-Section Window - Ample Shoulder Room for Mounting Side Entry Tractors

UNIVERSAL WEATHER BRAKE MODEL LIST

FOR MAKE AND MODEL	PART NUMBER
ALLIS CHALMERS ROW CROP MODELS	VINYL
WD and WD-45 (Gas Only)	307020897
D-14 (1958-59-60)	307020895+
D-15 (Gas & Diesel)	307020895+
D-17 (Gas & Diesel)	307020895+
D-17 Series III and IV (Gas, Diesel & LP)	307020895+
D-17 LPG (1958-59-60-61-62)	307020895+
D-19 (Gas & Diesel)	307020895+
D-21 Standard Tread Diesel also Series II	307020895+
One Eighty and One Eight Five (Gas & Diesel)	307020895+
One Seventy and One Seventy Five (Gas & Diesel)	307020895+
One Ninety, One Ninety XT, Two Hundred (G, D & LP)	307020895+
J. I. CASE ROW CROP MODELS	VINYL
DC	307020897
400 and 400 Diesel	307020897
Gas 541, 541C, Diesel 531, 531C	307020895+
Gas 641, 641C, Diesel 631, 631C	307020895+
Gas 711B, 713B, 811B, 741, 741C, 841, 841C, 843, 843C Diesel 701B, 703B, 801B, 803, 731, 731C, 831, 831C, 833, 833C	307020897
Diesel 731, 731C, 831, 831C, and Gas 741, 741C, 841, 841C (730 & 830 Comfort King S/N 8253501 & up)	307020895+
LPG 741, 741C, 841 and 841C Models (730-830 Series Comfort King S/N 8253501 & up)	307020895+
Gas or LPG 941 and Diesel 931 also 1031 General Purpose King Comfort (S/N 8253501 & up)	307020895+
Gas 540, 640, 640C; Diesel 530, 530C 540C, 630, 630C	307020895+

FOR MAKE AND MODEL	PART NUMBER
STANDARD TREAD & UTILITY MODELS - 1958 TO DATE	
Diesel 730, 730C, 830, 830C, gas 740, 740C, 840, 840C Standard 4-wheel models; Gas 732, 732C, 832, 832C, 842, 842C Western Specials Models (730-840 Comfort King S/N 8253501 & up)	307020895+
Diesel 930 and LPG 940 Standard 4-Wheel models Comfort King	307020895+
1032, 932, 942 Western Special Comfort King (Gas & Diesel)	307020895+
COCKSHUTT ROW CROP & UTILITY MODELS	VINYL
Cockshutt 35 and 40	307020897
Cockshutt 550, 560, 570	307020897
Cockshutt 550 Util. (Gas or Diesel)	307020896+
Cockshutt 770 Row Crop (Gas or Diesel)	307020897
Cockshutt 1550, 1555, 1600, 1650, 1655 with Standard and fuel tank fenders. (Gas or Diesel)	307020895+
Cockshutt 1800 Row Crop (Gas or Diesel)	307020895+
Cockshutt 1800 Series C, 1850, 1950 Row Crop (Gas or Diesel) (Adj. Steering Wheel)	307020895+
DAVID BROWN	VINYL
770, 880, 885, 900, 950, 990 and 4600	307020896+
1200, 1210, 1212, 1410, and 1412	307020895+
JOHN DEERE ROW CROP MODELS	VINYL
A, B and G (1947 to date)	307020897
520-50, 620-60, 720-70 (Distillate and Gas)	307020987
720-70 (Diesel)	307020897
520-50 LPG, 620-60 LPG, 720-70 LPG	307020897
530, 630, 730	307020897

+ Side Door Open Style

FOR MAKE AND MODEL	PART NUMBER
JOHN DEERE	VINYL
730 Diesel with Gas Engine Starter	307020897
530 LPG, 630 LPG, 730 LPG	307020897
1020 & 2020 R.U., L.U., & H.U. (Gas or Diesel)	307020896+
2010 Row Crop (Gas or Diesel)	307020895+
3010, 3020, 4010, Row Crop Models; 3020, 4320, 4020 Standard Tread; 3010, 4010 Standard Tread Models with Batteries Under Platform (Gas, Diesel, LPG)	307020895+
3010, 3020, 4010, 4020 Row Crop Models; 3020, 4320, 4020 Standard Tread; 3010, 4010 Standard Tread Models with Batteries Under Platform (Gas, Diesel, LPG)	307020897
4320, 4020, 3020, 2520, 4010, 3010, 2510 Row Crop, with or without Roll Guard	307020895+
4520 Diesel	307020895+
5020 Row Crop (Diesel)	307020895+
Lanz Models 710 and 510 Diesel	307020895+
2010 Utility, Gas and Diesel	307020895+
3010, 4010 Standard Tread with Battery Boxes on Fenders: 4010W, 4020W Ind. Models; Gas, Diesel, LPG	307020895+
3020, 4020 Standard Tread with Operator Shields - 1965 Model	307020895+
3010 Utility and Ind., (Gas, Diesel, LPG)	307020895+
5010 and 5020 Diesel Standard	307020895+
2840, 2940 and 3130	307020895+
INTERNATIONAL	VINYL
ROW CROP & UTILITY MODELS	
H and Super H, M Super M, Super MTA (Gas)	307020897
Farmall 300 and 350	307020897
Farmall 400, 450, 500 Diesel and 450 Diesel	307020897
F-460, F-560 (Gas, Diesel, LPG)	307020897
F-504 (Gas & Diesel)	307020895+
F-706, F-806, f-1206 (Gas, Diesel, LPG)	307020895+
F-656, F-544, F-666, Hydro 70, F-686 and Hydro 86	307020895+
F-756, F-856, F-826, F-1026, F-1456, F-1456 (Gas & Diesel) Including Hydrostatic Models	307020895+
STANDARD TREAD & UTILITY MODELS	
I-756, I-856, I-1256 (Gas or Diesel)	307020895+
I-826, I-1026, I-1456 (Gas or Diesel)	307020895+
FORD	VINYL
8N	307020896+
NAA, 600 and 800 (1955-56)	307020896+
700 and 900 (All Models); Also 2000 and 4000 Row Crop, 1964 and Prior	307020896+
600 and 800 (All Models); Also 2000 and 4000 All Purpose 1964 and Prior	307020896+
Fordson Super Major, Major, Power Major and 5000 Super Major, 1964 and Prior	307020895+
4000, 4600 All Purpose (Gas or Diesel) 1965 and Up	307020896+

FOR MAKE AND MODEL	PART NUMBER
4000 (4200) Row Crop (Gas or Diesel)	307020895+
5000 (5001) 5600, 6600, 7000, (7100) and 7600 All Purpose (Gas or Diesel) 1965 and up	307020896+
5200 Row Crop (Gas or Diesel)	307020895+
6000 and 6000 Commander (Gas or Diesel) All Models	307020895+
8000 Diesel	307020895+
MINNEAPOLIS-MOLINE	VINYL
ROW CROP & UTILITY MODELS	
U and U Diesel Row Crop (All Years), U Special and U Special Diesel	307020897
UB and UB Diesel, UB Special and UB Special Diesel	307020897
5 Star Gas or Diesel	307020895+
M-5, M-602, M604 (Gas and Diesel)	307020895+
Jet Star 3 (Gas and Diesel)	307020895+
U-302 (Gas and Diesel)	307020895+
M-670 (Gas, Diesel, and LPG)	307020895+
G-900 and G-1000 Row Crop (Diesel or LPG)	307020895+
Super M-670 (Gas and Diesel)	307020895+
FERGUSON	VINYL
M-FERGUSON, M-HARRIS	
30, 33, 44, 333, 444, and 44 Special	307020897
50 and 65 High Clearance or Row Crop, Gas, Diesel, and LPG; Ferguson Hi-40	307020896+
85 Row Crop Hi-Arch	307020895+
Super 90 Row Crop (Gas, Diesel, LPG)	307020895+
135 and 2135 (Gas or Diesel)	307020896+
150 Row Crop and Standard with Upright Exhaust Rear of Manifold (Gas or Diesel)	307020896+
165 Row Crop and Standard with Upright Exhaust Rear of Manifold (Gas or Diesel)	307020896+
175 Utility with Upright Exhaust Front of Manifold (G & D)	307020896+
180 Row Crop with Upright Exhaust Front of Manifold	307020895+
1100 & 1130 Row Crop or Hi Clearance (Diesel)	307020895+
35 Utility (Gas & 4 cyl. Diesel); Ferguson 35	307020896+
50 and 60 Utility (Gas, Diesel, LPG); Ferguson 40	307020896+
95 Super (1960), 95 and 97	307020897
WHITE-OLIVER	VINYL
ROW CROP MODELS	
77 and 88, 770 and 880, Gas or Diesel	307020897
White 2-70, 1150, 1555, 1600, 1650, 1655 with Standard and Fuel Tank Fenders (Gas and Diesel)	307020895+
1800 and 1900 Row Crop	307020895+
1800 Series C, 1850, 1950 Row Crop (Gas & Diesel) (Adj. Steering Wheel)	307020895+
STANDARD TREAD & UTILITY MODELS	
Super 55 and 550	307020896+
500 Utility	307020896+

UNIVERSAL SIZES

307020895 = Side Entry - Large *ABOVE 25 HP

307020896 = Side Entry - Sm **25 HP OR BELOW

307020897 = Rear Entry

UNIVERSAL WEATHER BRAKE COMPONENTS

WINDSHIELD SIDE
WINDOW ASSEMBLY
305020723

WINDSHIELD
305020722

LEFT SIDE WINDOW
305020705

RIGHT SIDE WINDOW
305020705

FEMCO, INC.

1132 W. 1ST STREET - McPherson, KS 67460 - (620) 241-3513 - FAX: (620) 241-3532 - TOLL FREE 1-800-677-0898
Web: www.femcomfg.com - Email: Femco@femcomfg.com



**YOUR SOURCE FOR WINTER WEATHER
PROTECTION PRODUCTS
IS PROUD TO OFFER**

THE 2142 WEATHER BRAKE



*ESPECIALLY DESIGNED FOR THE NEW HOLLAND BOOMER TC25/25D,
TC29/29D, TC33/33D, TC35/35D, TC40/40D, & TC45/45D SERIES OF TRACTORS
(WITH OR WITHOUT LOADER) NOT DA, DX OKAY*

CALL 1-800-677-0898

ORDER TODAY

Femco, Inc. is now online at

www.femcomfg.com

GENERAL OFFICES

1132 W. 1ST STREET

McPherson, KS 67460

Phone: 1-800-677-0898

Fax: (620) 241-3532

Web: www.femcomfg.com

Email: femco@femcomfg.com

SUMMER WEATHER PROTECTION

Engineered protection designed to install on most tractors.



With three models to choose from, these plastic canopies will fit many John Deere tractors. Canopies are constructed of strong, high impact ABS plastic and are covered with Korad for UV protection.



The New Generation 5 Universal Canopy

This new design incorporates "softer curves" for today's style of tractors. The canopy is constructed of white ABS plastic with a UV protective skin. With the included mounting hardware, this canopy will accommodate up to a 5" ROPS. The dimensions of the canopy are 48" wide by 52" long.

Femco Part Number **312013388**

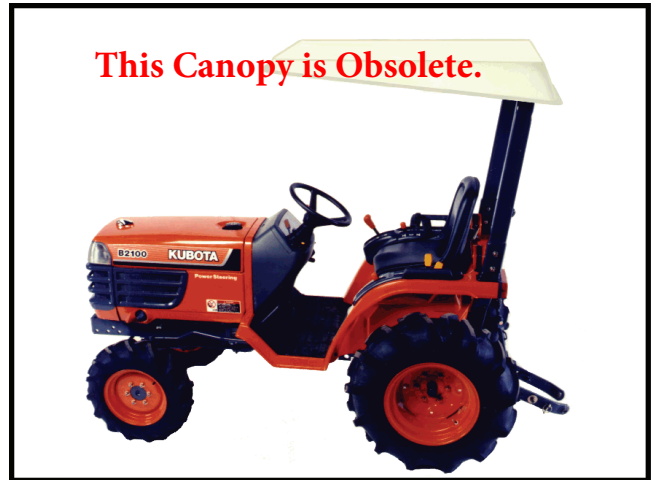

Universal Canopy

This white ABS Plastic canopy, with a UV protective skin, will fit most square and rectangular ROPS that are used on small to medium sized tractors. Our model **312013084**, fits 2-post ROPS through 44" in width.

FEMCO, Inc.

General Offices

1132 W. 1ST STREET
McPherson, KS 67460
Phone: 1-800-677-0898
Fax: (620) 241-3532
Web: www.femcomfg.com
Email: femco@femcomfg.com

312012513 CANOPY

FOR FOLDING AND FIXED ROPS



FITS JOHN DEERE C.U.T. MODELS:
4200-4700, 4210-4710, 5010 SERIES &
5020 SERIES. (DOES NOT FIT THE
5200, 5300, OR 5400) USE CANOPY
MODEL 312012455.

FEMCO, Inc.

YOUR SOURCE FOR WEATHER PROTECTION PRODUCTS PROUDLY INTRODUCES

The New Generation 5 UNIVERSAL CANOPY



- New design, that incorporates "softer curves" for today's style of tractor
- Constructed of ABS Plastic with a UV protective skin
- New and improved mounting hardware (see picture below)
- Accommodates up to 5" ROPS
- Canopy dimensions are 48 inches wide by 52 inches long

312013388 (WHITE) & 312013468 (GREY)
New Generation 5
Universal Canopy

For More Information or to Place an
Order Call

1-800-677-0898

Or Visit our Website

www.femcomfg.com



FEMCO, Inc.

GENERAL OFFICES
1132 W. 1ST STREET
McPherson, KS 67460
Phone 1-800-677-0898
Fax: 620-241-3532
Web: www.femcomfg.com
Email: femco@femcomfg.com

TUFFTOP

The convertible top for tractors and mowers

Installs, **Folds Down** for Trailering, or **Removes** in Seconds Without Tools!!!

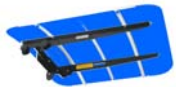

302022163
New Holland Blue



302022164
Case & M-F Red



302022162
Universal White



302022166
Deere Green



302022165
Kubota Orange

Call **1-800-677-0898** for the name of your nearest dealer.



UPS Shippable

- Strong steel frame is powder coated.
- Tough thermoplastic top panels and all parts easily replaced.
- Fits all ROPS equipped tractors with 2" square or 2" x 3" ROPS.
- Adjustable to fit: forward leaning, vertical or rear leaning ROPS.

SPECIFICATIONS

Height: Adds 5" to overall height of tractor once mounted to ROPS

Width: 44"

Length: 44"

Coverage: 13.23 sq. ft. actual

Adjustment Range: 11° Fore and Aft in 3° increments

Materials and Finishes: Steel framework and brackets are "e" coated and then powder coated. All hardware and fasteners are zinc plated. Top panels are .150" thick HDPE (high density polyethylene) with a laminated UV solar cap.)

Weight: Roll Bar Mounting Bracket: 8 lbs., Canopy: 24 lbs.

Shipping Weight: 39 Pounds



1132 W. 1ST STREET
McPherson, KS 67460
Phone: 1-800-677-0898
Fax: (620) 241-3532
Web: www.femcomfg.com
Email: femco@femcomfg.com

TUFFTOP

The convertible top for tractors and mowers

Installs & Folds Down | **Removes**



UPS Shippable

302022162
Universal White

- Strong steel frame is "e" coated and powder coated.
- Tough thermoplastic top panels and all parts easily replaced.
- Fits all ROPS equipped tractors with 2" square or 2" x 3" ROPS.
- Adjustable to fit: forward leaning, vertical or rear leaning ROPS.



SPECIFICATIONS

Height: Adds 5" to overall height of tractor once mounted to ROPS

Width: 44"

Length: 44"

Coverage: 13.23 sq. ft. actual

Adjustment Range: 11° Fore and Aft in 3° increments

Materials and Finishes: Steel framework and brackets are "e" coated and then powder coated. All hardware and fasteners are zinc plated. Top panels are .150" thick HDPE (high density polyethylene) with a laminated UV solar cap.)

Weight: Roll Bar Mounting Bracket: 8 lbs., Canopy: 24 lbs.

Shipping Weight: 39 Pounds

DISTRIBUTED BY



FFHGÁ ÈÚVÁUVÜÖVÁ
T&U@!·[] ÈSÚÁÍÍÍÉÁ
Ú@}^KFB ÈÈÍÍÈJÍÁ
O&KÇ GEDG FÈÍ HÇÁ
Y^àkÁ È^ &{ ~È{ Á
Ó ÈÍÈ{ & O^ &{ ~È{ Á

SNOWCO SUNSHADE



SNOWCO BUGGY TOP SUNSHADES PROVIDE SIMPLE INSTALLATION AND ADJUSTABILITY WITH A WIDE SHADE AREA. 2 SIZES AND A UNIVERSAL DESIGN ALLOWS IT TO FIT MOST AGRICULTURAL, CONSTRUCTION AND COMMERCIAL EQUIPMENT.

FEATURES:

- *MOUNTING BRACKET DESIGN WHICH ALLOWS IT TO FIT OVER MOST ROPS.
- *180 DEGREE FORWARD OR BACKWARD ROTATION
- *WATER RESISTANT CANVAS COVERS
- *PRE ASSEMBLED COMPONENTS MAKE FIELD ASSEMBLY FAST AND EASY.
- *YELLOW DICHROMATE ZINC PLATED STEEL PROVIDES A CORROSION RESISTENT, DURABLE FINISH, NO PAINTED PARTS.



GENERAL OFFICES
1132 W. 1ST STREET
McPherson, KS 67460
Phone: 1-800-677-0898
Fax: (620) 241-3532
Web: www.femcomfg.com
Email:
femco@femcomfg.com

Umbrellas

Insures protection against rain and sun

- For Tractors, Combines, Industrial and other equipment requiring operator sunshade protection.
- Umbrella covers are available in canvas or vinyl.
- Complete umbrella consists of cover, bracket, and frame.
- Metal parts are zinc-coated for long-lasting, maintenance-free service.
- Shafts constructed on 1 1/4" heavy duty steel tubing.
- Rigid framework for cover, withstands farm and industrial use.
- Universal mounting bracket adapts to all types of equipment.

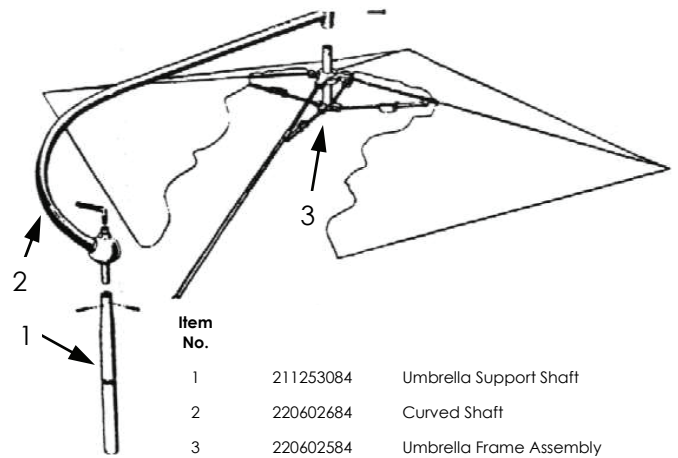
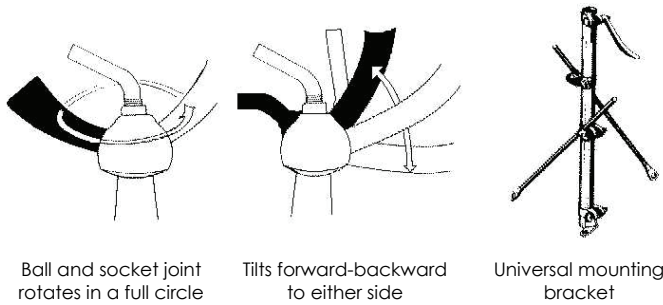

Item No.		
1	211253084	Umbrella Support Shaft
2	220602684	Curved Shaft
3	220602584	Umbrella Frame Assembly
	220604484	Universal Mounting Bracket*
	729212600	Hardware Bag**

* Shown at Left
** Not Shown

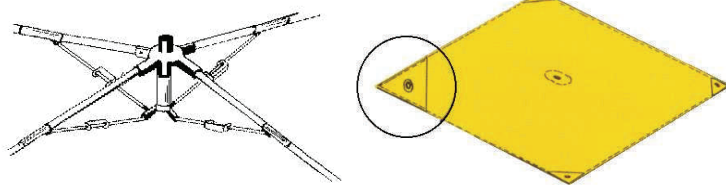

Frame features four tempered steel bows which are locked into place by a spring-steel clip.

Covers available in either canvas or vinyl. Reinforced corner grommets and center grommet.

Product	Product No.
1 of 2 Frame with bracket	315022126
Cover	
2 of 2 Yellow Canvas	311022014
Red Laminated Vinyl	311022015
Yellow Laminated Vinyl	311022029
Red Canvas	311022072
White Canvas	311022073



Provides maximum space for standing operator.

Tilts to any angle.

Folds to one side when not in use.

FEMCO, Inc.

GENERAL OFFICES

1132 W. 1ST STREET
McPherson, KS 67460
Phone: 1-800-677-0898
Fax (620) 241-3532
Web: www.femcomfg.com
Email: femco@femcomfg.com



1132 W. 1ST STREET
McPherson, KS 67460
(620) 241-3513
(800) 677-0898
Website: www.femcomfg.com

Introducing the newest edition to our line of Sun Protection

RU-50 ROPS Umbrella

For Mounting on Roll Over Protection Bar



Simple and effective way to protect yourself from the sun. It mounts directly to the ROPS structure without drilling. Comes complete with umbrella frame, mounting bracket and cover.

Complete ROPS Umbrella part numbers listed below

Part#: 405969—ROPS Umbrella/Mounting Brkt./Yellow Canvas Cover

Part#: 405968—ROPS Umbrella/Mounting Brkt/ White Canvas Cover

Fits tube sizes 2" x 2" up to 3" x 3" only

Also available in complete kits with the following colors:

#405967 Complete kit w/ Red cover

#405966 Complete kit w/ Orange cover

Replacement Covers:

#405074 Green, #405373 Red, #405370 Blue, #405518 Orange

#405600= ROPS Umbrella/Mtg. Brkt./ Less Cover

The TU-46 Lawn & Garden Umbrella

*Get your sun
protection
today!*



- **Simple Installation**
- **Fits most lawn and grounds care equipment**
- **Built to withstand strong winds**
- **41.5" for lawn and grounds applications**
- **Made with water resistant canvas duck covers**

FEMCO, Inc.

GENERAL OFFICES
1132 W, 1ST STREET
McPherson, KS 67460
Phone: 1-800-677-0898
Fax: (620) 241-3532
Web: www.femcomfg.com
Email: femco@femcomfg.com